

Die Serum- und Glukokortikoid – induzierbare kinase in
der Regulation von natriumgekoppelten
Aminosäuretransportern

The Serum and Glucocorticoid inducible Kinase in the
regulation of sodium coupled amino acid transporters

EBERHARD KARLS
UNIVERSITÄT
TÜBINGEN



der Fakultät für Biologie

der Eberhard Karls Universität Tübingen

zur Erlangung des Grades eines Doktors der Naturwissenschaften

von

Jeyaganesh Rajamanickam

aus Madurai, Indien

vorgelegte

Dissertation

2007

Tag der mündlichen Prüfung : 07.03.2007
Dekan : Prof. Dr. Friedrich Schöffl
1. Berichterstatter : Prof. Dr. Florian Lang
2. Berichterstatter : Prof. Dr. Fritz Götz

CONTENTS

ABBREVIATIONS	1
1 ZUSAMMENFASSUNG	3
2 SUMMARY	6
3 INTRODUCTION	9
3.1 THE SERUM AND GLUCOCORTICOID INDUCIBLE KINASE SGK1	9
3.2 THE PROTEIN KINASE B	13
3.3 THE UBIQUITIN LIGASE NEDD4-2	16
3.4 GLUTAMATERGIC NEUROTRANSMISSION	20
3.4.1 <i>Excitatory Amino Acid Transporters (EAATs)</i>	23
3.4.2 <i>The Excitatory Amino Acid Transporter 2 (EAAT2)</i>	25
3.4.2.1 <i>The Excitatory Amino Acid Transporter 4 (EAAT4)</i>	26
4 AIM OF THE STUDY	28
5 MATERIALS AND METHODS	30
5.1 SITE DIRECTED MUTAGENESIS	30
5.1.1 <i>Transformation of E.coli XL1-Blue Supercompetent Cells</i>	34
5.2 PREPARATION OF CRNA	34
5.2.1 <i>Plasmid DNA linearization</i>	35
5.2.2 <i>cRNA synthesis</i>	36
5.3 <i>XENOPUS LAEVIS</i> OOCYTE PREPARATION	37
5.4 PROTEIN EXPRESSION IN <i>XENOPUS LAEVIS</i> OOCYTES	39
5.5 NEDD4-2 RNA SILENCING BY siRNA	40
5.6 TRACER FLUX MEASUREMENTS	41
5.7 DETECTION OF CELL SURFACE EXPRESSION BY CHEMILUMINESCENCE	42
5.8 WESTERN BLOTTING	44
5.9 STATISTICAL ANALYSIS	45
6 RESULTS	46
6.1 MODULATION OF EAAT2 BY SGK1-3 AND PKB	46
6.1.1 <i>SGK1 stimulates EAAT2 activity and plasma membrane abundance</i>	46
6.1.2 <i>SGK1 isoforms SGK2-3 and PKB similarly stimulate Nedd4-2 plasma membrane abundance</i> ...	47
6.1.3 <i>SGK1 enhances EAAT2 by inhibiting Nedd4-2 effects without altering Nedd4-2 expression</i>	49
6.2 MODULATION OF EAAT4 BY SGK1	53
6.2.1 <i>SGK1 enhances EAAT4 mediated glutamate transport</i>	53
6.2.2 <i>Disruption of the putative SGK1 phosphorylation sites (Thr40 and Thr504) on EAAT4 abrogates transporter stimulation</i>	54
6.2.3 <i>Phosphorylation at Thr40 on EAAT4 is essential for transporter stimulation</i>	56
6.2.4 <i>Phosphorylation at Thr40 on EAAT4 is required for enhanced EAAT4 plasma membrane abundance</i>	58
6.2.5 <i>Nedd4-2 coexpression inhibits the activity of EAAT4</i>	59
6.2.6 <i>Silencing of intrinsic xNedd4-2 upregulates EAAT4 function</i>	60
6.2.6.1 <i>xNedd4-2 siRNA downregulates xNedd4-2 expression</i>	62
6.2.6.2 <i>xNedd4-2 siRNA does not alter GLUT1 expression</i>	62
7 DISCUSSION	64
8 REFERENCES	68
ACKNOWLEDGEMENT	89
CURRICULUM VITAE	90

ABBREVIATIONS

2-DOG	2-deoxy-D-glucose
AMPA	α -amino-3-hydroxy-5-methyl-4-isoxazole propionic acid
ALS	Amyotrophic lateral sclerosis
ATP	Adenosine triphosphate
BSA	Bovine serum albumin
cAMP	Cyclic adenosine monophosphate
CNS	Central nervous system
cRNA	Complementary ribonucleic acid
EAATs	Excitatory amino acid transporters
EGFR	Epidermal growth factor receptor
ENaC	Epithelial sodium channel
FSH	Follicle stimulating hormone
Gln	Glutamine
Glu	Glutamate
GLUT1	Glucose transporter1
HA	Haemagglutinin
HECT	Homologous to E6AP-carboxyl-terminus
HEK293	Human embryonic kidney cells 293
HEPES	4-(2-hydroxyethyl)-1-piperazineethanesulfonic acid
IGF-1	Insulin-like growth factor-1
Nedd4-2	Neuronal cell expressed developmentally downregulated 4-2
NMDA	N-methyl-D-aspartate
PBS	Phosphate buffered saline
PCR	Polymerase chain reaction
PDGF	Platelet derived growth factor
PDK	3-phosphoinositide-dependent protein kinase
PI3K	Phosphatidylinositol 3-kinase
PKB	Protein kinase B
RISC	RNA induced silencing complex
RLU	Relative light units
ROMK1	Renal outer medullary potassium channel
Ser	Serine
SGK	Serum and glucocorticoid inducible protein kinase

Abbreviations

siRNA	Short interference ribonucleic acid
TGF- β	Transforming growth factor- β
Thr	Threonine
TM	Transmembrane domain
VGLUT	Vesicular glutamate transporter

1 Zusammenfassung

Die Serum- und Glukokortikoid-induzierbare Kinase 1 (SGK1) ist eine Proteinkinase welche die Funktion und Expression verschiedener Ionenkanäle und Membrantransporter reguliert. Das Gen wird in Tumor- und Fibroblastenzelllinien unter dem Einfluss von Serum und Glukokortikoiden aufreguliert. Die Kinase wird durch Phosphorylierung aktiviert durch Signale die weiter oberhalb in der Signalkaskade die PI3 -Kinase aktivieren. Die Phosphorylierung erfolgt durch die Phosphoinositid-abhängige Kinasen 1 (PDK1) und PDK2. Bei Aktivierung phosphoryliert SGK1 ihre Ziele an einer spezifischen Konsensus-Stelle (Arg-Xaa-Arg-Xaa-Xaa-Ser/Thr) oder indirekt durch die Inhibition der Ubiquitinligase Nedd4-2. Die Ubiquitinligase Nedd4-2 katalysiert ihrerseits die Anlagerung eines Ubiquitinrestes an ihre Ziele, die sie damit für die Degradation durch das Proteasom markiert.

Der natriumgekoppelte exzitatorische Aminosäuretransporter EAAT2 ist der wichtigste Glutamatttransporter im zentralen Nervensystem der höheren Vertebraten. EAAT2 hält die extrazelluläre Konzentration des Glutamats unter toxischem Niveau. Eine gestörte Expression des Transporters führt zu Exzitotoxizität und trägt möglicherweise zu Krankheiten wie etwa der amyotrophischen lateralen Sklerose (ALS) bei. SGK1 ist im Gehirn exprimiert, interagiert dort mit der Ubiquitinligase Nedd4-2 und moduliert Membrantransporter und Ionenkanäle. Die vorliegende Studie untersucht ob SGK1 und ihre Isoformen SGK2 und 3 sowie die Proteinkinase B (PKB) EAAT2 regulieren.

Dazu wurde die cRNA des EAAT2 allein oder zusammen mit den jeweiligen Kinasen im Expressionssystem *Xenopus laevis* exprimiert und die [³H]-Glutamat Aufnahme als ein Maß für die EAAT2-Aktivität gemessen. Funktionelle Studien zeigten, dass die EAAT2-Aktivität durch Koexpression sowohl der SGK1 als auch ihrer Isoformen 2, 3 und PKB stimuliert wurde. Kürzlich konnte gezeigt werden, dass diese Kinasen auch potente Regulatoren des EAAT1 sind. Dieser stimulierende Effekt auf die EAAT1-Aktivität wird durch eine direkte Phosphorylierung des Transporters an der SGK-Phosphorylierungsstelle und einer Interaktion mit der Ubiquitinligase Nedd4-2 verursacht. Da EAAT2 keine SGK1-

Konsensusstelle enthält wurde untersucht, ob die Regulation des EAAT2 auf einer Interaktion mit der Ubiquitinligase Nedd4-2 beruht. In der Tat zeigte sich, dass der Transporter durch die Koexpression der Ligase Nedd4-2 inhibiert wird, ein Effekt der wiederum durch die Koexpression der SGK1 aufgehoben wird. Die Proteinkinase inhibiert die Ubiquitinligase Nedd4-2 durch ihre Phosphorylierung ohne, wie in Western Blots gezeigt, die Abundanz der Ligase zu verändern. Durch Chemilumineszenz konnte zudem gezeigt werden, dass die Stimulierung der EAAT2-Aktivität durch eine Erhöhung der Expression des Proteins an der Zelloberfläche verursacht wird. Die Erhöhung der EAAT2 Oberflächenexpression durch die Proteinkinase SGK ist möglicherweise ein neuer Mechanismus in der Regulation der neuronalen Erregbarkeit.

Der exzitatorische Aminosäuretransporter EAAT4 ist primär in den Purkinje Zellen und im cerebralen Cortex exprimiert. In diesen Zellen bewirkt der Transporter niedrige Konzentrationen des Glutamats unter toxischem Niveau. In einer vorherigen Studie konnte gezeigt werden, dass EAAT4 Abundanz und Funktion durch SGK1 und Nedd4-2 moduliert werden, aber der grundlegende Mechanismus konnte dabei nicht aufgeklärt werden. Expressionsstudien in *Xenopus* Oocyten zeigten, dass die [3H]-L-Glutamataufnahme und -oberflächenexpression durch die SGK1 gesteigert und durch die Ubiquitinligase Nedd4-2 vermindert werden. Ziel der vorliegenden Arbeit ist es, den molekularen Mechanismus der EAAT4-Modulation durch die Kinase zu erklären.

Im Gegensatz zum EAAT2 besitzt die Sequenz des EAAT4 zwei putative SGK1 Konsensus-Stellen am Amino- und Carboxy-Terminus (Thr40 und Thr504) die zwischen den verschiedenen Organismen stark konserviert sind. Um die potentielle Bedeutung dieser SGK Phosphorylierungsstellen in der EAAT4-Modulation durch die Proteinkinase aufzuklären wurden beide Stellen deletiert und das mutierte Protein allein oder zusammen mit der SGK1 exprimiert. Die Deletion beider SGK1 Phosphorylierungsstellen auf dem EAAT4-Protein (T40A, T504A) reduzierte den stimulierenden Effekt der Kinase auf die Funktion des Transporters und seine Oberflächenexpression. Von den beiden Phosphorylierungsstellen ist nur die erste (Thr40) für den stimulierenden Effekt verantwortlich da die ^{T40A}EAAT4 Aktivität und Abundanz nicht weiter durch die Proteinkinase moduliert wird. Die SGK1 hat möglicherweise, wie beim EAAT2 beschrieben, durch die Inhibition der

Ubiquitinligase Nedd4-2 einen zusätzlichen Effekt auf EAAT4. Die Koexpression der SGK1 hebt den inhibierenden Effekt der Nedd4-2 auf und stimuliert dadurch die Expression des Transporters. Die Beteiligung der Ubiquitinligase Nedd4-2 an der Inhibition des EAAT4 konnte durch RNA-Interferenz nachgewiesen werden.

Die durch RNA-Interferenz vermittelte Inhibition der endogenen Nedd4-2 (xNedd4-2)- aktiviert die EAAT4-Funktion welche weiterhin durch die zusätzliche Expression der SGK1 stimuliert wird. In der Zusammenfassung moduliert die SGK1-Kinase die Aktivität des EAAT4 durch die Phosphorylierung des Transporters am Thr40 und auf indirektem Wege durch die Inhibition der Ubiquitinligase Nedd4-2. Deshalb spielt die SGK1 Proteinkinase möglicherweise eine wichtige Rolle bei der Homöostase der neuronalen Erregbarkeit im zentralen Nervensystem.

2 Summary

The Serum and Glucocorticoid inducible Kinase 1 (SGK1) is a protein kinase which regulates the function and expression of several ion channels and transporters. It was initially recognized as an immediate early gene whose mRNA level is increased in mammary tumour cell and fibroblast cell lines upon serum or glucocorticoids. The kinase is activated by phosphorylation in response to signals that stimulate phosphatidylinositol 3-kinase. The phosphorylation is mediated by 3-phosphoinositide-dependent protein kinase1 (PDK1) and PDK2/H-motif kinase. Once phosphorylated, the kinase regulates its targets activity through phosphorylation at the SGK1 consensus site (Arg-Xaa-Arg-Xaa-Xaa-Ser/Thr) or indirectly through inhibition of the ubiquitin ligase Nedd4-2. Nedd4-2 is an ubiquitin protein ligase that mediates binding of ubiquitin to its target proteins which tags them for degradation by the proteasome.

The sodium dependent excitatory amino acid transporter EAAT2 is a major glutamate carrier in the mammalian central nervous system. EAAT2 maintains the level of extracellular glutamate below the excitotoxic level. Defective expression of the transporter results in neuroexcitotoxicity that may contribute to neuronal disorders such as amyotrophic lateral sclerosis (ALS). SGK1 is expressed in the brain and interacts with the ubiquitin ligase Nedd4-2 to modulate membrane transporters and ion channels. The present study aimed to investigate whether SGK1 and its isoforms SGK2 and SGK3 as well as the related kinase, protein kinase B (PKB), regulate EAAT2.

To this end cRNA encoding EAAT2 alone or along with the kinases was expressed in *Xenopus laevis* oocytes and [³H] L-glutamate uptake was determined as a measure of EAAT2 activity. Functional studies demonstrated that EAAT2 activity is stimulated by coexpression of SGK1, its isoforms SGK2 and SGK3 as well as PKB. Regulation of the closely related glutamate transporter EAAT1 was recently shown to involve SGK1-3. The effect of these kinases on EAAT1 is mediated, in part, by direct phosphorylation of EAAT1 at the SGK1 consensus site on the transporter and by interference with the downregulating effect of the ubiquitin ligase Nedd4-2. Since EAAT2 does not contain any SGK consensus site, we

addressed whether the kinases modulate EAAT2 by impacting Nedd4-2 effects. In fact, the function of EAAT2 was diminished by Nedd4-2, an effect abrogated by additional coexpression of SGK1. The kinase inhibits Nedd4-2 through phosphorylation without altering Nedd4-2 protein abundance as demonstrated by western blotting of whole cell lysates. Chemiluminescence assays revealed that stimulation of EAAT2 activity is caused by the enhancement of the transporter abundance in the cell surface. Enhanced EAAT2 abundance by SGK1 might represent a novel mechanism in the regulation of neuronal excitability.

The excitatory amino acid transporter EAAT4 is predominantly expressed in Purkinje cells of cerebellar cortex. In those cells, EAAT4 keeps the level of extracellular glutamic acid in synaptic cleft below the toxic level. In a previous study EAAT4 abundance and function were shown to be modulated by SGK1 and Nedd4-2 but the precise mechanism of action remained illdefined. Expression studies in *Xenopus* oocytes demonstrated that EAAT4-mediated [³H] L-glutamate uptake and cell surface abundance are enhanced by coexpression of SGK1 and downregulated by coexpression of Nedd4-2. The present work aimed to identify the molecular mechanism of EAAT4 modulation by the kinase.

In contrast to EAAT2, EAAT4 sequence bears two putative SGK1 consensus sites at the amino and the carboxy terminus (Thr40 and Thr504) that are conserved among several species. To investigate the role of these putative SGK1 phosphorylation sites in EAAT4 modulation by SGK1, both sites were deleted and the mutated protein expressed alone or together with the kinase. Disruption of both SGK1 phosphorylation sites on EAAT4 (^{T40A}^{T504A}EAAT4) reduced the kinase effect on transporter function and plasma membrane expression. From both phosphorylation sites, Thr40 appears to be responsible for the stimulatory effect since ^{T40A}EAAT4 activity and abundance was not further modulated by the kinase. SGK1 may additionally modulate transport through inhibition of the ubiquitin ligase Nedd4-2 as observed with the EAAT2 transporter. Coexpression of SGK1 inhibits the downregulating effect of Nedd4-2 on EAAT4 and thus stimulates the expression of the transporter. The significance of Nedd4-2 in the downregulation of EAAT4 was demonstrated by silencing intrinsic (*Xenopus*) Nedd4-2.

RNA interference-mediated silencing of endogenous Nedd4-2 (xNedd4-2) increased EAAT4 activity that was further stimulated upon additional SGK1 expression. In conclusion, the SGK1 kinase modulates EAAT4 activity through phosphorylation of the transporter at Thr40 and indirectly through inhibition of the ubiquitin ligase Nedd4-2. Hence SGK, through the regulation of EAAT2 and EAAT4 activity and expression might maintain proper neuronal excitability in the central nervous system.

3 Introduction

3.1 *The Serum and Glucocorticoid inducible Kinase SGK1*

The Serum and Glucocorticoid inducible protein Kinase 1 (SGK1) was identified in 1993 as an immediate early gene whose mRNA level increases noticeably within 30 minutes when mammary tumour or fibroblast cells are stimulated with serum or glucocorticoids¹⁻³. SGK1 gene transcription was also shown to occur rapidly in response to many agonists like mineralocorticoids⁴⁻⁶, follicle stimulating hormone (FSH)^{7,8}, transforming growth factor (TGF- β)^{9,10}, thrombin¹¹, hypertonicity¹²⁻¹⁴, high glucose^{9,11} and neuronal injury or excitotoxicity^{15,16}.

SGK1 is a member of the 'AGC' subfamily of serine/threonine protein kinases, which include protein kinase A (PKA) or adenosine 3', 5' monophosphate (cAMP)-dependent protein kinase, protein kinase G (PKG) or guanosine 3', 5' monophosphate (cGMP)-dependent protein kinase and isoforms of protein kinase C (PKC). SGK1 is present in the genomes of all eukaryotic organisms examined so far, including *Caenorhabditis elegans*, *Drosophila*, fish and mammals. Structure of SGK1 has been highly conserved through evolution like many other protein kinases^{8,13,17}.

There are two other isoforms of SGK1 that have been identified in mammals and are named as SGK2 and SGK3. The catalytic domains of SGK2 and SGK3 isoforms share 80% amino acid sequence identity with one another and with SGK1¹⁴. The human gene encoding SGK1 was found in chromosome 6q23¹⁷. The gene encoding SGK2 was identified in chromosome 20q12 and SGK-like gene which encodes a protein having predicted amino acid sequence identical to that of human SGK3¹⁸ was found in chromosome 8q12.2.

SGK1 is expressed in all human tissues that have been studied including the pancreas, liver, heart, lung, skeletal muscle, placenta, kidney and brain¹³ but SGK1 is not expressed in all cell types within those tissues. For example, SGK1 transcript levels are found high in acinar cells in the pancreas¹⁹. High transcript levels of SGK1 are also found in the distal tubule and collecting duct of the kidney and in

thick ascending limb epithelial cells⁹. The expression of SGK2 mRNA is restricted in human tissues. It express most abundantly in liver, kidney and pancreas²⁰. As like SGK1, SGK3 mRNA is present in all human and murine tissues examined but expression is particularly high in the mouse heart and spleen and in the embryo^{20,21}.

SGK1 has been observed as cytosolic in differentiated cells such as luteal cells^{22,23} or in tumour cells arrested in the G₁ phase of the cell division cycle by glucocorticoids²⁴. It has also been observed as nuclear in proliferating glomerulosa cells^{22,23} or mammary tumour cells during the S and G₂-M phases of the cell cycle²³. However, the localization of SGK1 in any given cell is regulated by extracellular signals. Thus, in serum-stimulated mammary epithelial cells, the endogenously expressed SGK1 is nuclear, but becomes cytosolic after the inhibition of phosphatidylinositol (PI) 3-kinase. Translocation from the cytosol to the nucleus also occurs in response to serum stimulation of HEK293 or COS cells transfected with SGK1²⁵.

SGK1 is activated by phosphorylation through a signaling cascade including phosphatidylinositol (PI) 3-kinase and phosphoinositide dependent kinase PDK1 and PDK2/H-motif kinase. While PDK1 phosphorylates SGK1 at ²⁵⁶Thr, PDK2/H-motif kinase phosphorylates the kinase at ⁴²²Ser. SGK2 and SGK3 may similarly be activated by PDK1 and PDK2/H-motif kinase. The equivalent phosphorylation sites for SGK2 and SGK3 are found at ¹⁹³Thr/³⁵⁶Ser and ²⁵³Thr/⁴¹⁹Ser, respectively^{14,20,25}.

Replacement of the serine at position 422 by aspartate in the human SGK1 leads to the constitutively active ^{S422D}SGK1 whereas replacement of lysine at position 127 with asparagine leads to the constitutively inactive ^{K127N}SGK1. Analogous mutations in SGK2 and SGK3 lead to the constitutively active ^{S356D}SGK2 and ^{S419D}SGK3, and the constitutively inactive ^{K64N}SGK2 and ^{K191N}SGK3¹⁴.

SGK isoforms resemble PKB in the substrate specificity, recognizing a serine or threonine residue lying in Arg-Xaa-Arg-Xaa-Xaa-Ser/Thr sequence (where Xaa is a variable amino acid) and thereby phosphorylating it^{14,20,25}.

SGK1 has a considerable physiological role through the regulation of transporters and ion channels. Sodium channel conductance stimulated by SGK1

may result in cell volume regulation^{12,13,26}. SGK1 mediated activation of sodium channels leads to Na⁺ entry which in turn depolarizes the cell membrane. The depolarized cell membrane allows the entry of chloride ions and the accumulation of NaCl that further increases the intracellular osmolarity. The osmotic gradient makes water to enter the cell by which the volume of cell increases^{27,28}. SGK1 was found to stimulate Na⁺, K⁺ and 2Cl⁻ cotransporter activity in the thick ascending limb of the kidney, a key nephron segment in urinary concentration, which is of importance in renal Na⁺ reabsorption⁹. Abundant SGK1 gene transcription has been observed in diabetic nephropathy^{10,11,29}, fibrosing pancreatitis¹³ and inflammatory bowel disease¹⁹ but SGK1 involvement in the formation of abnormal fibrosis tissues remains to be established.

Moreover SGK1 and its isoforms are well proved in stimulating the activity and the cell membrane abundance of several transporters and ion channels. For instance, SGK isoforms regulate the epithelial Na⁺ channel, ENaC⁵, the voltage-gated Na⁺ channel, SCN5A³⁰, the K⁺ channels ROMK1³¹, KCNE1/KCNQ1³² and K_v1.3³³⁻³⁵, the Na⁺/H⁺ exchanger NHE3³⁶, the dicarboxylate transporter NaDCT³⁷, the glutamate transporters EAAT1³⁸, EAAT3³⁹, EAAT4⁴⁰ and EAAT5⁴¹ and the Na⁺/K⁺-ATPase⁴². The regulatory activity of SGK1 plays a diverse role in essential cell functions such as epithelial transport, excitability, cell proliferation and apoptosis.

SGK1 might regulate epithelial Na⁺ transport via enhancing ENaC activity^{5,26,43} which has been proven to regulate transepithelial Na⁺ transport in kidney, lung and colon⁴⁴. The K⁺ channel KCNQ4 maintains electrical excitability in inner and outer hair cells of the inner ear and its activity is significantly stimulated by SGK1. KCNQ4's function is responsible for hearing ability and loss-of-function mutations in KCNQ4 gene leads to hearing loss^{45,46}. Hence SGK1 mediated stimulation of KCNQ4 activity might be necessary for excitability and it could contribute to the beneficial effect of glucocorticoids in hearing loss or vertigo^{47,48}. The role of SGK1 in the regulation of excitatory amino acid transporters (EAAT1, 3-5) is well established^{38,39,41}. The excitatory amino acid transporters maintain glutamate below toxic levels in the synaptic cleft of CNS and prevent severe neurological diseases such as amyotrophic lateral sclerosis⁴⁹⁻⁵² and ischemia⁵³⁻⁵⁵.

The influence of SGK1 in regulation of K^+ channel further indicates its importance in cell proliferation³³⁻³⁵. K^+ channels are considered to be important to maintain the cell membrane potential which is in turn required for proper function of the Ca^{2+} release-activated Ca^{2+} channel (I_{CRAC})⁵⁶. I_{CRAC} mediates Ca^{2+} entry upon stimulation of cells with a wide variety of mitogenic factors, a prerequisite for triggering cell proliferation⁵⁷. SGK1 has been found involving in antiapoptotic pathway in part to phosphorylation of forkhead transcription factors, such as FKRHL1^{21,58}. SGK1 has also been shown to inhibit apoptosis of breast cancer cells⁵⁹.

To date, two modes of SGK1 action in regulating transporters and ion channels have been identified. It either regulates transporters by phosphorylating them at the putative consensus site (Arg-Xaa-Arg-Xaa-Xaa-Ser/Thr) or by inhibiting the downregulating effect of protein ubiquitin ligase Nedd4-2. These two modes of regulation of SGK1 were observed in epithelial Na^+ channel, ENaC^{60,61} (Figure 1).

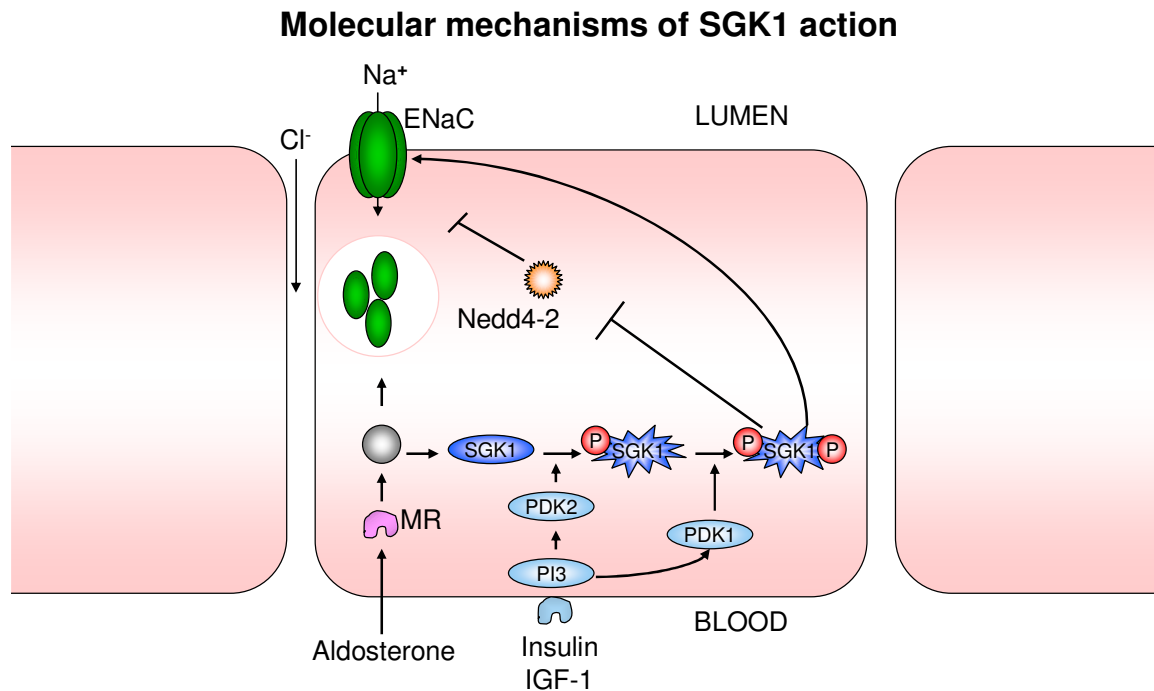

Figure 1 Schematic model showing molecular mechanisms of ENaC regulation by SGK1. Aldosterone binding to the mineralocorticoid receptor (MR) can stimulate the transcription of SGK1 as well as ENaC. Insulin or Insulin-like growth factor (IGF-1) phosphorylates SGK1 at Ser422 through PI3 kinase and PDK2/H-motif kinase signaling cascade. Activated (phosphorylated) SGK1 enhances ENaC plasma membrane abundance either directly by phosphorylating the channel or indirectly by inhibiting the downregulating effect of the ubiquitin ligase Nedd4-2.

3.2 The Protein Kinase B

The serine/threonine kinase Akt or protein kinase B (PKB) was discovered in 1991 in two independent lines of research. Bellacosa's group cloned the cellular homologue of the v-akt oncogene from a transforming retrovirus (AKT8) in spontaneous thymoma of the AKR mouse and named its product as c-AKT^{62,63}. Similarly Akt/PKB cDNA was cloned by Coffey's group while searching for novel members of the protein kinase C (PKC) and by Jones's groups while studying protein kinase A (PKA) superfamily as possible participants in signal transduction cascades^{64,65}. Jones' group isolated a cDNA that encoded a protein kinase, termed RAC (related to the A and C kinases)⁶⁵. The newly found kinase contains

consensus sequences characteristic of a protein kinase catalytic domain and shows 73% and 68% similarity to PKC and PKA respectively⁶⁵.

Three major isoforms of Akt/PKB namely, Akt1/PKB α , Akt2/PKB β and Akt3/PKB γ encoded by three separate genes have been found in mammalian cells⁶⁶⁻⁶⁹. These three isoforms have greater than 85% sequence identity and share the same protein structural organization. The first 100 amino acids of amino-terminal tail bear a pleckstrin homology (PH) domain that binds phospholipids. A short glycine-rich region that bridges the PH domain to the catalytic domain follows the PH domain. The last 70 amino acids of carboxy terminal tail contain a putative regulatory domain. All three Akt/PKB isoforms possess conserved threonine and serine residues (T308 and S473 in Akt1/PKB α)⁶⁶⁻⁶⁹.

Akt/PKB isoforms are ubiquitously expressed in mammals, although the levels of expression vary among tissues⁶⁶⁻⁷¹. Akt1/PKB α is the predominant isoform in most tissues including brain where it is markedly increased in regenerating neurons. Akt2/PKB β expression is observed high in insulin-responsive-tissues comprising skeletal muscle, heart, liver and kidney⁶⁶. Akt2/PKB β expression is further substantiated in developing embryos⁷⁰. In contrast to the first two isoforms, Akt3/PKB γ shows restricted pattern of expression. It expresses at high levels in testis and brain and low levels in the adult pancreas^{67,69,71}.

Akt/PKB isoforms can be rapidly activated by platelet derived growth factor (PDGF) studies in rodent fibroblasts showed that Akt/PKB is directly activated by PI3 kinase, which is activated by growth factor receptors through binding of its regulatory subunit to phosphotyrosine residues in the receptor^{72,73}. This is strongly suggested by the dependency of PKB on tyrosines Y740 and Y752 in the PDGF receptor that had been identified as the binding sites for the p85 regulatory subunit of PI3 kinase⁷³. PI3 kinase mediated PKB activation was also proved by the inactivation of PKB by the PI3 kinase inhibitors wortmannin and LY94002⁷²⁻⁷⁴. Mechanism of Akt1/PKB α activation is recognized well and some studies demonstrate that same mechanism is true for both Akt2/PKB β and Akt3/PKB γ according to different tissues and in response to different stimuli^{70,75,76}.

Akt/PKB possesses two phosphorylation sites, at carboxy-terminal tail (S473) and at activation loop of the kinase domain (T308), which are essential for the kinase activation by growth factors. Akt/PKB is activated by growth factors through the PI3 kinase signaling cascade. The growth factor which is recognized by tyrosine kinase receptors activates PI3 kinase which in turn catalyzes production of phosphoinositides phosphorylated at position 3 (PI(3,4,5)P₃). PI(3,4,5)P₃ binds to the PH domain of PDK1 and Akt/PKB and also activates PDK2/H-motif kinase. Activated PDK1 and PDK2/H-motif kinase phosphorylate Akt/PKB at S473 and T308 respectively and anchor the kinase to the plasma membrane (Figure 2)⁷⁵.

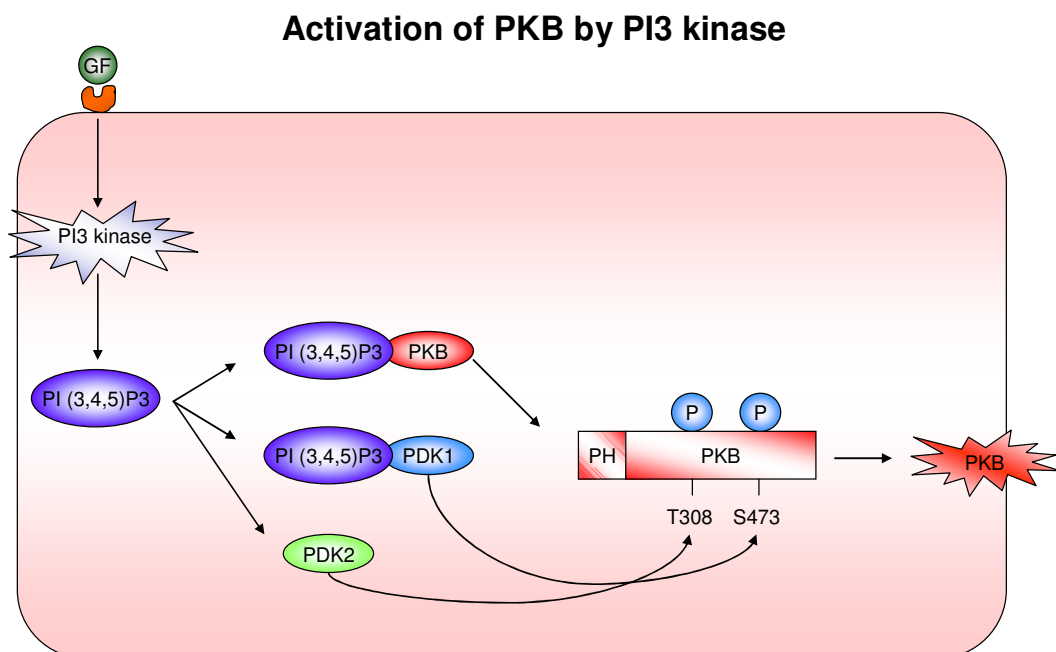

Figure 2 An outline of PKB activation by growth factor through PI3 kinase signalling cascade.

The PI3 kinase mediated Akt/PKB activation suggests that Akt/PKB might be involved in growth factor mediated cell survival⁷⁷⁻⁸⁰ and might be capable of regulating basic metabolic functions such as protein and lipid synthesis, carbohydrate metabolism and transcription⁷⁵. The Akt/PKB isoform used in this study is Akt1/PKB α . Specifically T^{308D}, S^{473D}PKB mutant was employed and mimics the activated (phosphorylated) state by PDK1/2.

3.3 The Ubiquitin ligase Nedd4-2

The ubiquitination of proteins is an essential step in the degradation or processing of intracellular proteins in eukaryotic cells. This selective event takes place by conjugation of multiple ubiquitin molecules with target proteins. The ubiquitinated protein is in turn a target for a large 26S protease complex known as proteasome^{81,82} (Figure 3). The covalent attachment of ubiquitin, a highly conserved 76-amino acid polypeptide, to lysine residues of a substrate protein is required for proteasomal degradation^{81,83,84}.

Protein ubiquitination involves the cascade of three classes of enzymes: the ubiquitin-activating enzyme E1, the ubiquitin-conjugating enzyme (Ubc) or E2 and the ubiquitin-protein ligase E3⁸¹. The E1 enzyme first activates an ubiquitin through the formation of a high-energy thiol ester bond between the carboxyl-terminal glycine of ubiquitin and the thiol group of a cysteine residue of E1. The ubiquitin is then transferred to a cysteine residue on one of the E2 members. The E2 enzymes may catalyse the attachment of the single ubiquitin to a substrate protein directly, or transfer the ubiquitin to E3 proteins. The E3 enzyme can catalyse the formation of an isopeptide bond between the carboxyl-terminal glycine of ubiquitin and the ϵ -amino group of lysine residues on a target protein. The attachment of additional ubiquitins by E3 enzyme eventually results in a multiply ubiquitinated substrate. The E3 is therefore believed to recognize specific substrate proteins that do not associate with E2 alone⁸⁵.

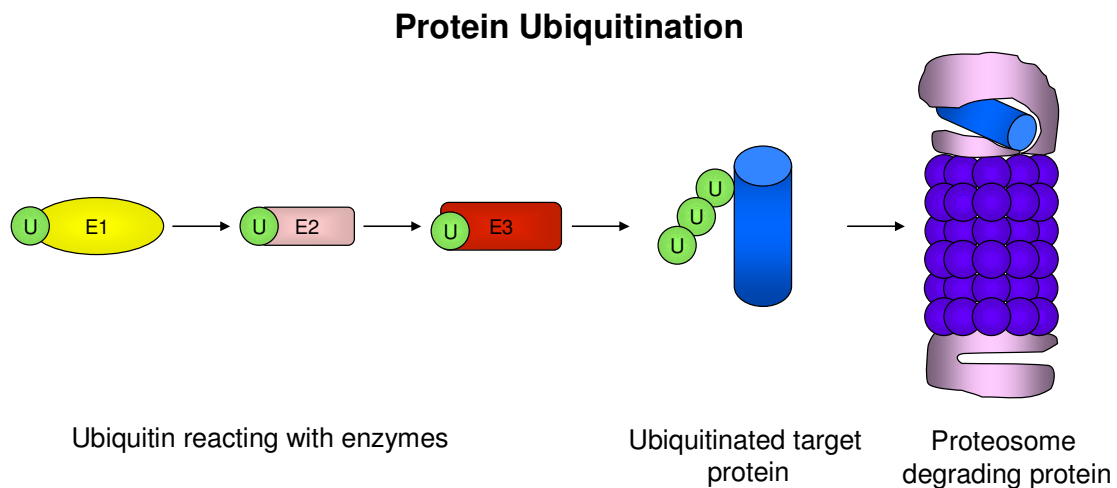

Figure 3 Protein ubiquitination involves the cascade of three classes of enzymes E1- the ubiquitin-activating enzyme, E2- ubiquitin-conjugating enzyme and E3-ubiquitin ligase enzyme. 26S proteasome recognizes the ubiquitinated protein and degrades it.

Human associated protein (E6AP) is an E3 enzyme that has been identified as functioning as an ubiquitin-protein ligase of tumour suppressor protein P53 in the presence of E6 onco-protein from human papilloma virus types 16 and 18^{86,87}. Putative E3 proteins contain a conserved region of approximately 350 amino acids homologous to the carboxyl-terminus of E6AP, termed 'the homologous to E6AP carboxyl-terminus' (HECT) domain⁸⁸. Nedd4 ubiquitin protein ligase is one of the HECT-E3 proteins⁸⁹ and has been well studied in regulating ion channels and transporters including ENaC⁹⁰⁻⁹³ and EAAT1³⁸. Nedd4 ['NPC (Neuronal Precursor Cells)-Expressed, Developmentally Down-regulated 4'] gene was identified in 1992 as a developmentally regulated mouse gene highly expressed in early embryonic central nervous system. Nedd4 expression is not only restricted to the embryonic CNS⁹⁴, but is also expressed abundantly in tissues such as cortical collecting ducts in kidney^{95,96} and lung epithelia which are important tissues for Na⁺ channel function⁹⁴.

The Nedd4 has two isoforms namely Nedd4-1 (also named Nedd4, KIAA0093, or RPF1) and Nedd4-2 (also known as KIAA0439, LDI-1, Nedd4La, Nedd18, or Nedd4-L). The isoforms of Nedd4 has been studied intensively in the regulation of epithelial Na⁺ channel (ENaC)⁹⁶⁻⁹⁸. Nedd4-1 has one N-terminal calcium-dependent lipid binding domain (C2), a domain homologous to the E6-AP-COOH-terminal (HECT) and three to four WW domains with approximately 40

amino acids which are protein-protein interaction modules found in a variety of proteins⁹⁸. WW domains derive their name from the presence of two highly conserved tryptophan (W) residues and a conserved proline residue in the sequence of ~35 amino acids⁹⁹. These domains have a preference for binding small proline-rich sequences present in the target proteins called PY motifs, the most common of which is PPxY⁹⁹ (P being proline and Y tyrosin residues). WW domains of some proteins can bind to alternative proline-rich motifs like PPLP¹⁰⁰, L being a leucin residue. The catalytic region of Nedd4, the HECT domain, contains a conserved cysteine residue that serves as an active site for the formation of thiol ester bond with an ubiquitin^{87,88,101}.

Nedd4-2 in the rat and mouse species has three WW domains, whereas in humans there are four WW domains which may be due to alternative splicing, as there is evidence for multiple transcripts in human Nedd4-1¹⁰². Nedd4-2 has four WW domains and a HECT domain. Only *Xenopus laevis* Nedd4-2 comprise a C2 domain, whereas such a domain appears to be lacking in mouse Nedd4-2⁹⁸. Figure 4 illustrates the structure of human and *Xenopus* Nedd4-2.

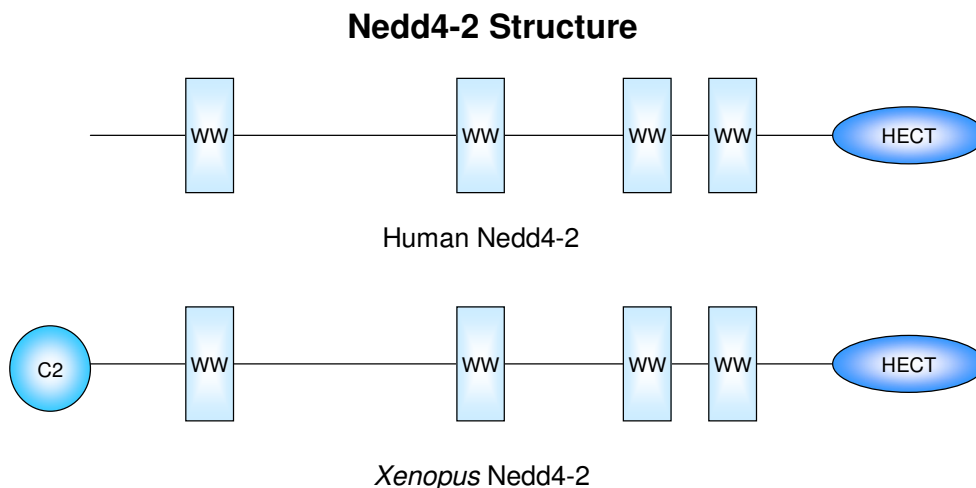

Figure 4 Schematic illustration of human and *Xenopus* Nedd4-2. Both human and *Xenopus* Nedd4-2 contain four WW domains and a HECT catalytic domain. Only *Xenopus* Nedd4-2 bears a C2 domain.

Nedd4-2 has several SGK1 phosphorylation sites which can be phosphorylated by SGK1 that leads to inactivation of the ubiquitin ligase (Figure 5).

By inactivating Nedd4-2, SGK1 can enhance the expression and activity of transporters (EAAT4)⁴⁰) and ion channels (ENaC)⁶⁰) indirectly.

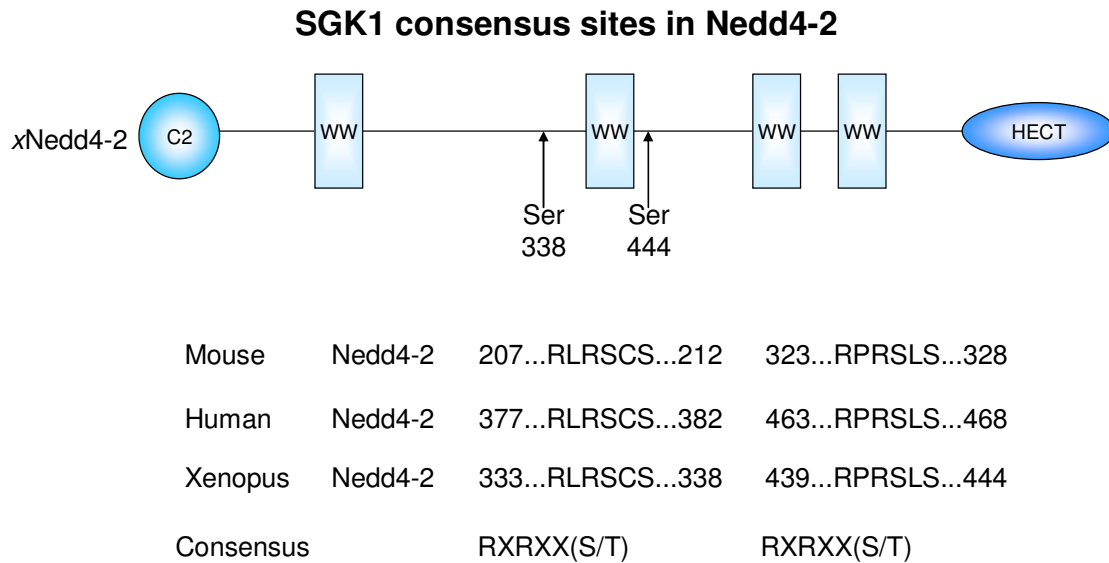

Figure 5 The xNedd4-2 sequence possesses two putative SGK1 phosphorylation sites at Ser338 and Ser444. Consensus sites of SGK1 in mouse and human Nedd4-2 are also indicated below.

Nedd4-2 mediated regulation is well studied in ENaC. The WW domains 3 and 4 of Nedd4-2 bind to the PY motif of ENaC and ubiquitinate the channel. Upon ubiquitination, ENaC is internalized and deubiquitinated. The deubiquitinated ENaC is either degraded by the lysosomes or relocated to the plasma membrane⁹⁷. Figure 6 shows the ENaC downregulation by Nedd4-2.

Nedd4-2 mediated ENaC downregulation

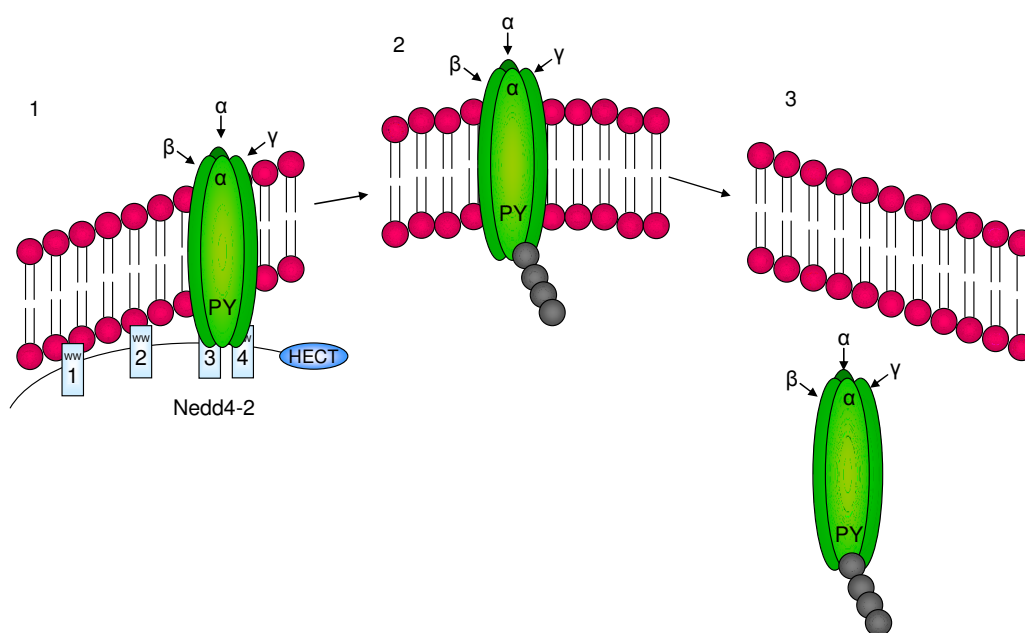

Figure 6 Nedd4-2 recognizes (1), ubiquitinates (2) and thus internalizes (3) the epithelial Na⁺ channel ENaC.

3.4 Glutamatergic Neurotransmission

The amino acid L-glutamate is a major excitatory neurotransmitter in the mammalian central nervous system and is involved in most aspects of normal brain function including cognition, memory and learning¹⁰³⁻¹⁰⁵. Glutamate also plays major roles in the development of the central nervous system, including synapse induction and elimination, and cell migration, differentiation and death¹⁰⁶. It has been implicated in many important physiological processes such as developmental plasticity, pathological conditions including epilepsy, cerebral ischemia, amyotrophic lateral sclerosis, Alzheimer's disease, Parkinson's disease and schizophrenia¹⁰⁷.

The glutamatergic neurotransmission begins with the release of glutamate from the synaptic vesicles to the synaptic cleft by exocytosis. The released glutamate activates three families of protein receptors¹⁰⁷. One family of glutamate receptors are NR1, NR2A, NR2B, NR2C and NR2D. They are collectively known as NMDA-receptors because they are activated by the glutamate analogue N-methyl-D-aspartate (NMDA). Second family of receptors is called AMPA and kainate receptors, which are activated by α -amino-3-hydroxy-5-methyl-4-isoxazole

propionic acid (AMPA) and kainate respectively. AMPA-receptors are divided into subgroups namely GluR1-4 and kainate receptor's subgroups are GluR5-9, KA1 and KA2. The NMDA and AMPA/kainate receptors are glutamate gated ion channels and are termed as ionotropic glutamate receptors. G-protein coupled receptors comprise the third family of glutamate receptors and are named as metabotropic receptors which are subdivided into groups I (mGluR1 and mGluR5), group II (mGluR2 and mGluR3) and group III (mGluR4, mGluR6, mGluR7 and mGluR8)¹⁰⁷. The glutamate neurotransmission is terminated by uptake of excessive glutamate from the synaptic cleft.

Glutamate uptake is accomplished by means of glutamate transporter proteins which use the electrochemical gradients across the plasma membrane as driving forces for uptake¹⁰⁸. Both neurons and glial cells express glutamate transporters (EAATs). Glutamate taken up by the cells may be used for metabolic purposes (protein synthesis, energy metabolism, ammonia fixation) or be reused as transmitter¹⁰⁷. Glutamate is transported into synaptic vesicles by a vesicular glutamate transporter (VGLUT) and subsequently released by exocytosis¹⁰⁹⁻¹¹². In astrocytes, glutamate taken up from the extracellular fluid may be converted to glutamine which is released to the extracellular fluid, taken up by neurons and reconverted to glutamate inside neurons¹⁰⁷ (Figure 7).

Glutamatergic neurotransmission

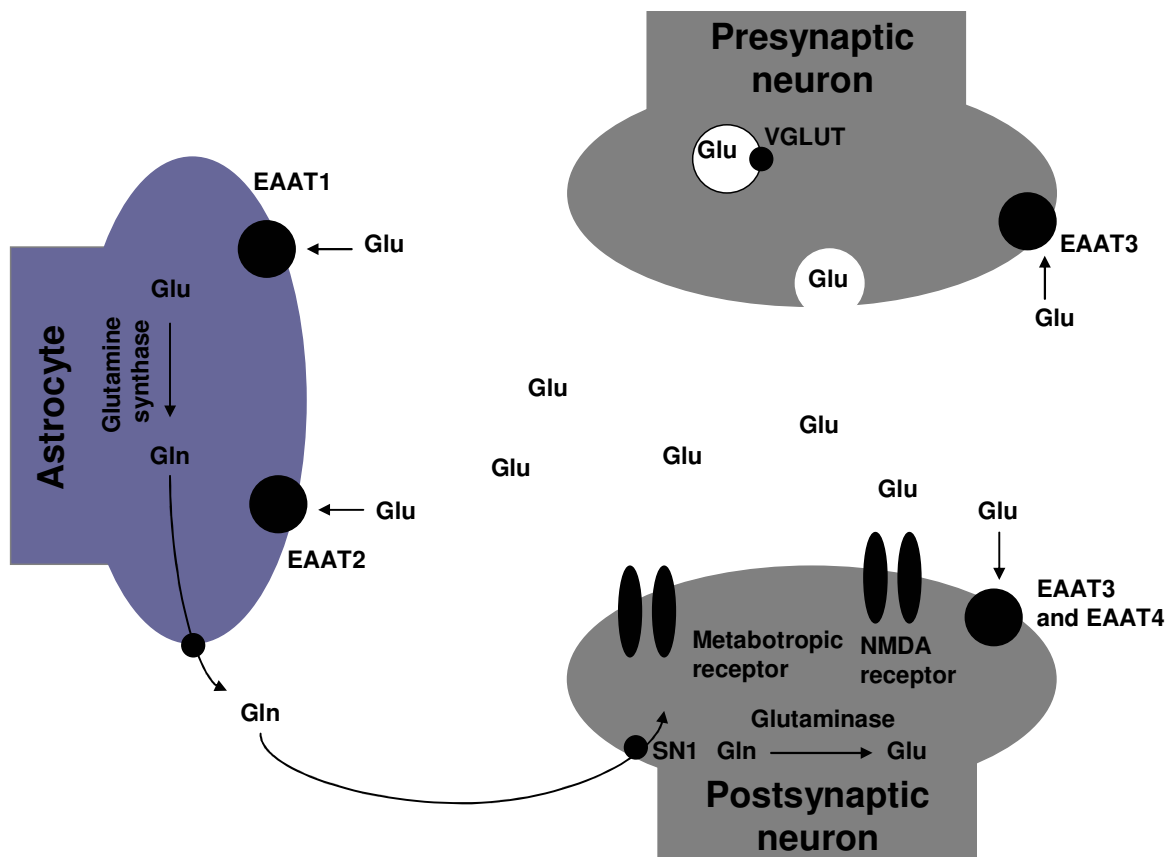

Figure 7 A schematic outline of glutamatergic neurotransmission. Upon an action potential glutamate (Glu) contained in vesicles in the presynaptic neurons is released to the synaptic cleft. Released glutamate activates glutamate (metabotropic and ionotropic-NMDA) receptors present on the post-synaptic neurons. To terminate transmission and in order to avoid excitotoxicity, glutamate is taken up by excitatory amino acid transporters (EAATs). Glutamate taken up by the cells may be stored in transmitter vesicles or be used for metabolic purposes. In neurons glutamate is transported into synaptic vesicles by a vesicular glutamate transporter (VGLUT). In astrocytes glutamate may be converted to glutamine (Gln). Released glutamine may be taken up by transporters (SN1) on neurons and converted to glucose.

The brain contains huge amounts of glutamate (about 5-15 mmol per kg wet weight depending on the region) and only a tiny fraction of this glutamate is normally present extracellularly¹¹³. Glutamate uptake is a mechanism responsible for the maintenance of low extracellular concentrations of glutamate in the synaptic cleft. A defect in uptaking glutamate from the synaptic cleft results in the

accumulation of glutamate that causes neuroexcitotoxicity and neurodegeneration which is seen in epilepsy¹¹⁴⁻¹¹⁶, ischemia⁵³⁻⁵⁵ and amyotrophic lateral sclerosis⁴⁹⁻⁵².

3.4.1 Excitatory Amino Acid Transporters (EAATs)

Excitatory amino acid transporters (EAATs) in the central nervous system (CNS) maintain extracellular glutamate concentration below excitotoxic levels and contribute to the clearance of glutamate released during neurotransmission¹⁰⁶. At least five structurally distinct subtypes of human glutamate transporters, EAAT1 – EAAT5 have been identified and characterized by molecular cloning.

In 1992, three groups simultaneously isolated cDNA clones of these transporters. Kanner's group purified a transport protein from rat brain with biochemical methods¹¹⁷ and isolated a cDNA clone identified as GLT1 by using sequence information derived from a peptide fragment of this protein¹¹⁸. Hediger's group used expression cloning to isolate a clone called EAAC1 (Excitatory Amino Acid Carrier) from a cDNA library prepared from rabbit intestine¹¹⁹.

Stoffel's group while isolating a uridine diphosphate (UDP) galactose: ceramide galactosyltransferase from brain, always observed a co-chromatographing protein. After analysis of its sequence, they found a high homology to a bacterial H⁺-dependent EAA transporter. A cDNA clone encoding a protein called GLAST (glutamate and aspartate transporter) was then isolated¹²⁰. Amara's group isolated the human homologues of all three transporters and introduced the term EAAT1-3 for Excitatory Amino Acid Transporter¹²¹. EAAT1 is homologue of GLAST, EAAT2 is homologue of GLT1 and EAAT3 is homologue of EAAC1. The sequence similarity of these transporters was used to obtain two other EAA transporter clones called EAAT4 and EAAT5^{122,123}.

EAATs have been isolated from a variety of eukaryotic species, including human (hEAAT1-5)¹²¹⁻¹²⁴, rat (GLAST-1, GLT-s, rEAAC1)^{118,120,125}, mouse (mEAAT1, mEAAT2, mEAAC1, mEAAT4)¹²⁶⁻¹³¹, rabbit (EAAC1)¹¹⁹, Salamander (sEAAT1, -2A, -2B, -5A, -5B)¹³², cow (bGLAST)¹³³ and *Drosophila melanogaster* (dEAAT)¹³⁴. In prokaryotes, gene encoding proton-dependent L-glutamate

transporters from *E.coli* (GltP), *Bacillus stearothermophilus* (GltT)^{135,136}, and *Bacillus caldotenax* (GltT) and dicarboxylic acid transporter (DctA) from *Rhizobium meliloti*¹³⁷ are shown relatively high homology to the eukaryotic EAA carriers¹⁰⁸.

EAATs are predominantly localized on presynaptic neurons and glial cells¹⁰⁶. EAAT1 and EAAT2 are distributed abundantly on astrocytic plasma membranes throughout the CNS¹³⁸. Among the five subtypes EAAT2 is the most abundant glutamate transporter localized in the CNS. EAAT1 is the second abundantly present transporter¹⁰⁷. EAAT3 is found in highest concentrations in the hippocampus, cerebellum (Purkinje cells) and basal ganglia^{139,140}. EAAT4 is selectively expressed on a GABAergic cell type, the cerebellar Purkinje cell and appears concentrated adjacent to excitatory synapse where glial cell membranes contact dendritic spines¹⁴¹⁻¹⁴³. EAAT5 appears to serve a unique signalling function in photoreceptors of retina^{122,132,144}. Three other EAATs are also been found in retina. They are EAAT1 in the Müller glial cells, EAAT2 in cone photoreceptors and cone bipolar cells, and EAAT3 in horizontal cells, amacrine cells and ganglion cells^{145,146}.

Hydropathy analysis of excitatory amino acid transporters predicts six strongly hydrophobic transmembrane helices in the N-terminal half of the transporter and anywhere from 4-6 membrane-spanning regions in the C-terminal half¹⁰⁸.

The conserved amino acid sequences of EAATs evidences to be highest in the C-terminal half of the transporter and in the putative transmembrane domains, whereas the least conserved regions are at the N and C termini¹⁰⁸. 'AAXFIAQ' motif in the C-terminal half of the transporter is noticeably conserved in both eukaryotic and prokaryotic members of this family and plays important role in transporter function¹⁰⁸. EAAT1-3 have two consensus sites for N-linked glycosylation (NXS/T) located in a large hydrophilic loop between 3rd and 4th transmembrane domains (TMs). EAAT4 and EAAT5 have three and one N-linked glycosylation sites respectively¹⁰⁸.

Among the five glutamate transporters, only EAAT1 and EAAT4 have SGK1/PKB consensus sites on their sequence. EAAT1 has a consensus SGK1

phosphorylation site at Thr482 and EAAT4 has two putative SGK1 phosphorylation sites at Thr40 and Thr504. PKC is found to phosphorylate and internalize EAAT1¹⁴⁷⁻¹⁵⁰ and EAAT2^{149,151-153}. PKC mediated phosphorylation reduces the activity and cell surface expression of both EAAT1¹⁴⁷⁻¹⁵⁰ and EAAT2^{147,149,151-153}. A 43 amino acid domain in the C terminal of EAAT2 is necessary for PKC-dependent internalization¹⁴⁹. PKC activation increases EAAT3 mediated activity in C6 glioma cells and in *Xenopus* oocytes¹⁵⁴ and cell surface expression in neuron-enriched cultures^{149,155}, but controversially, Trotti *et al* found that activation of PKC decreases EAAT3 mediated activity and cell surface expression in *Xenopus* oocytes or in Madin-Darby Canine kidney cells¹⁵⁶. The precise mechanism of PKC mediated regulation of glutamate transporters is still elusive.

Transportation of glutamate by EAATs is an electrogenic phenomenon. The inward movement of glutamate across the membrane is thermodynamically coupled with the influx of two or three sodium ions and one proton and the efflux of one potassium ion¹⁵⁷⁻¹⁵⁹. The cotransport of sodium ions provides the driving force for the concentrative uptake of glutamate which is necessary for maintaining low extracellular CNS concentration of glutamate¹⁰⁸. In addition, EAAT4 and EAAT5 possess ion channel like properties by adopting ligand-gated chloride conductance of substrate transport.

3.4.2 The Excitatory Amino Acid Transporter 2 (EAAT2)

The sodium coupled glutamate transporter EAAT2 is distributed abundantly on astrocytic plasma membranes associated with excitatory synaptic contacts¹⁶⁰⁻¹⁶². It is abundantly expressed in all brain regions, including the hippocampus, lateral septum, cerebral cortex and striatum.

EAAT2 is thermodynamically coupled to an inwardly directed sodium gradient. Glutamate influx is coupled to the cotransport of two to three sodium ions, one proton and the counter-transport of a potassium ion¹⁵⁷⁻¹⁵⁹. The current generated by EAAT2 through Cl⁻ conductance is relatively small^{106,108,163}. It has two consensus N-linked glycosylation sites encoded in a large hydrophilic loop between 3rd and 4th transmembrane domains (TMs)¹⁰⁸.

Among the five subtypes of human EAATs, EAAT2 is the most abundant transporter in the CNS. Together with EAAT1, EAAT2 has the greatest impact on clearance of glutamate released during neurotransmission^{107,140,141,160,162,164}. As glutamate may exert neurotoxic effects, defective function or regulation of astroglial EAAT2 expression may foster neuroexcitotoxicity¹⁶⁵⁻¹⁶⁸. Lack of EAAT2 has indeed been shown to promote extracellular glutamate accumulation, excitotoxicity and ultimately cell death. EAAT2 dysfunction has been reported in amyotrophic lateral sclerosis (ALS)¹⁶⁹.

Despite the fundamental role of EAAT2 in CNS glutamate shuttling, only few studies have addressed the regulation of trafficking and function of this carrier. To date EAAT2 has been shown to be regulated by protein kinase C (PKC)^{153,170,171}. PKC phosphorylates and internalizes EAAT2^{149,151-153}.

In the present study, coexpression experiments in *Xenopus laevis* oocytes have been used to examine the influence of SGK1, its isoforms SGK2 and SGK3 and the related protein kinase PKB on the glial glutamate transporter EAAT2.

3.4.2.1 The Excitatory Amino Acid Transporter 4 (EAAT4)

EAAT4 belongs to the family of sodium coupled glutamate transporters, which is predominantly expressed on a GABAergic cell type, the cerebellar Purkinje cells which are particularly sensitive to neuronal death and appears to be concentrated in dendritic areas that receive major glutamatergic inputs^{106,172}.

To escape neuroexcitotoxicity, Purkinje cells clear extracellular glutamate by Na⁺ coupled uptake, a function served by the glutamate transporter EAAT4¹⁴³. During ischemia, lack of EAAT4 correlates with loss of Purkinje cells supporting a role of EAAT4 in the protection of those cells¹⁷³. Efficient neuronal protection would require the adjustment of EAAT4 activity to the demand.

As like EAAT2, the transport of glutamate by EAAT4 is thermodynamically driven by an inwardly directed sodium gradient. Glutamate influx is coupled to the

cotransport of two to three sodium ions, one proton and the counter-transport of a potassium ion¹⁵⁷⁻¹⁵⁹. EAAT4 also shows ligand gated chloride conductance as like EAAT5^{123,134,174}. The EAAT4 sequence bears three N-linked glycosylation sites and two putative SGK1 consensus sites (Thr40 and Thr504) at the amino and carboxy terminus that are conserved among several species.

The presence of the SGK1 consensus sites on the EAAT4 protein sequence suggests that the transporter might be directly phosphorylated by SGK1. In a previous study, EAAT4 activity and plasma membrane expression was shown to be upregulated by SGK1. The mechanism of SGK1 action remained however elusive. From ENaC regulation studies, SGK1 was found to stimulate the activity and the expression of ENaC by hindering the downregulating effect of the protein ubiquitin ligase Nedd4-2, but this mechanism of SGK1 action has not yet been demonstrated in the SGK1 mediated regulation of EAAT4.

4 Aim of the Study

The Serum and Glucocorticoid inducible protein Kinase 1 (SGK1) is well known to upregulate several ion channels and transporters such as the epithelial Na⁺ channel, ENaC, the renal chloride channel ClC-Ka/barttin, the K⁺ channel ROMK, the excitatory amino acid transporter EAAT4, and the sodium dependent glucose transporter SGLT1. The kinase exert its effects directly through phosphorylation of its targets or indirectly through inhibition of the ubiquitin ligase which otherwise tag its targets for internalization and degradation.

The major aim of this current work was to study the putative regulation of two sodium dependent glutamate transporters, EAAT2 and EAAT4, by SGK1 and Nedd4-2 in the *Xenopus laevis* oocyte expression system. Considering the key role of EAAT2 in regulating glutamate concentrations in the CNS, the elucidation of a regulatory mechanism of EAAT2 function and expression might have important implications in the regulation of neuroexcitability in health and disease.

This study aimed not only at investigating the significance of SGK1 in EAAT2 modulation but also of its isoforms SGK2 and SGK3 as well as PKB. Given that the closely related glutamate transporters EAAT1 is modulated by SGK1 in part through interference with the downregulating effect of the ubiquitin ligase Nedd4-2, the present work addressed whether the kinases modulate EAAT2 by impeding Nedd4-2 effects. The possibility that SGK1 and Nedd4-2 affect each others expression was also considered.

Recent studies demonstrated the ability of SGK1 to stimulate the activity and plasma membrane abundance of the excitatory amino acid transporter 4 (EAAT4). However the mechanism of SGK1 action remained elusive.

The present work was driven to identify the molecular mechanism of EAAT4 modulation by the kinase. The EAAT4 protein sequence bears two putative SGK1 phosphorylation sites which suggest SGK1 direct phosphorylation as the mechanism of EAAT4 modulation by the kinase. Here we investigated whether none, both or only a unique site is required for the SGK1 stimulatory effect. Nedd4-

2 has also been reported to modulate EAAT4 activity. Thus, SGK1 might enhance EAAT4 by inhibiting intrinsic *Xenopus* Nedd4-2. This mechanism of SGK1 action was also analysed.

5 Materials and Methods

5.1 Site Directed Mutagenesis

In order to quantify surface abundance of EAAT2 and EAAT4 on the oocytes membrane, an hemagglutinin tag (HA-tag) was introduced in an extracellular loop of transporters by two-stage PCR site-directed mutagenesis. The expression of HA-tagged transporters could be detected by a chemiluminescence assay by using an anti-HA antibody.

At the first stage of the two-stage PCR site-directed mutagenesis, two separate PCR reactions were performed, one with the forward primer and another with the reverse primer (Table 1) containing the HA sequence flanked by EAAT2 and EAAT4 specific sequences. In the second stage, the PCR products were mixed and further amplified as a single reaction. The first PCR consisted on 4 cycles of 30s at 94°C; 30s at 95°C; 1min at 55°C; 2 min at 68°C and the second PCR consisted on 18 cycles of 30s at 94°C; 30s at 95°C 1min at 55°C; 2 min at 68°C. Table 2 indicates the composition of the PCR mixture as suggested by Stratagene (Heidelberg, Germany). Figure 8 shows a schematic outline of two-stage site-directed mutagenesis method.

Protein	Forward Primer	Reverse Primer
EAAT2-HA	5'GTCCAGCCTGGATTAC GACGTACCAGATTACGC TGCCTTCCT GGACC 3'	5'GGTCCAGGAAGGCA GCGTAATCTGGTACGT CGTAATCCAGGCTGGAC 3'.
EAAT4-HA	5' GGGTCAGAGTTGGGG TACGACGTACCAGATTAC GCTGCCTCCATTTCTCC 3'	5' GGAGAAATGGAGG CAGCGTAATCTGGTAC GTCGTACCCCAACTCT GACCC 3'.

Table 1 Forward and reverse primers used to generate EAAT2-HA and EAAT4-HA.

PCR reaction mixture	Quantity
10X Pfu buffer	5 μ l
10 mM primer	1 μ l
Plasmid template	0.1 – 0.2 μ g
10 mM dNTP mix	1 μ l
H ₂ O	Final volume of 50 μ l
<i>Pfu</i> turbo polymerase	1 μ l

Table 2 PCR reaction mixture for two-stage PCR site-directed mutagenesis.

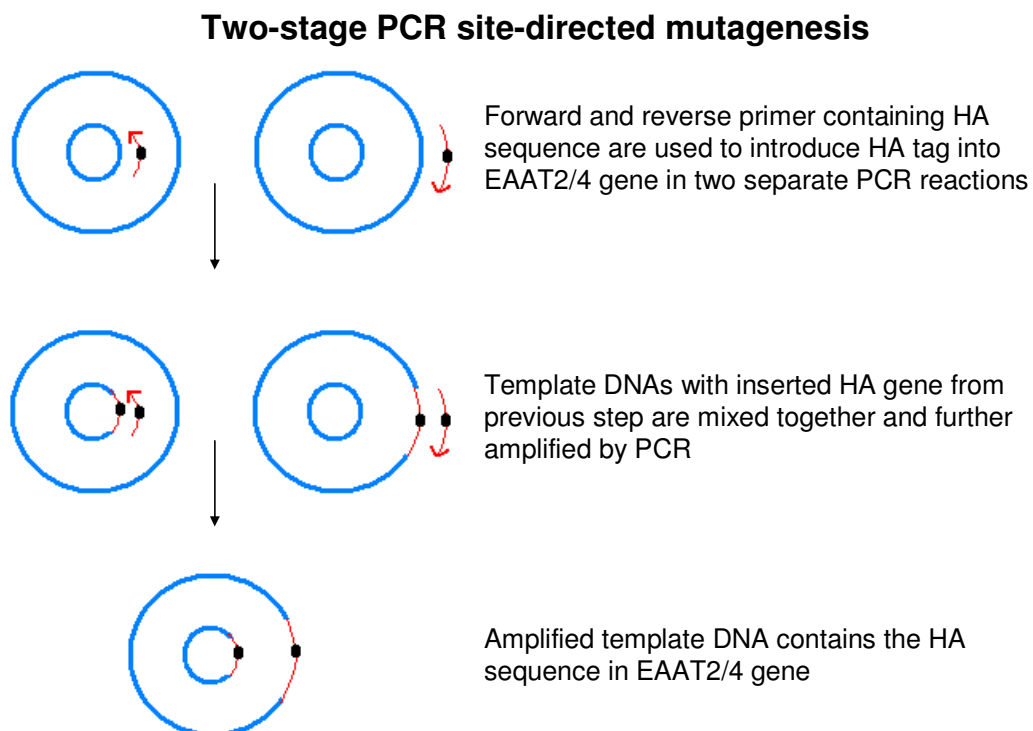

Figure 8 Main steps of two-stage PCR site-directed mutagenesis.

The final PCR product contains a mixture of wildtype and mutated plasmid DNA. In order to get rid of the wildtype DNA, the PCR product was digested with 1 μ l of *Dpn* I enzyme (10U/ μ l) which only digests methylated parent (template) DNA. The *Dpn* I digested PCR product was then transformed into *E.coli* XL1-Blue Supercompetent cells by a heat shock method and plated onto LB plates. Grown

bacteria were picked and inoculated into LB media for further DNA isolation and RNA synthesis. Mutants were sequenced to verify the presence of the desired mutation.

The site-directed mutagenesis technique was also performed to eliminate putative SGK1 phosphorylation sites on EAAT4. The phosphorylation sites at Thr40 and Thr504 position on EAAT4 were eliminated separately to generate ^{T40A}EAAT4, ^{T504A}EAAT4 single mutants according to the manufacturer's (QuikChange site-directed mutagenesis kit, Stratagene, Heidelberg, Germany) instructions. By using ^{T40A}EAAT4 as a template, phosphorylation site at Thr504 position on EAAT4 was eliminated to generate the double mutant ^{T40AT504A}EAAT4 which lacks both SGK1 phosphorylation sites. These mutants were used to study the stimulation of EAAT4 activity and plasma membrane abundance by SGK1 in the absence of one or both phosphorylation sites. The primers used to generate these mutants are listed in Table 3 below. All other mutants used in this work were prepared by other collaborators. Table 4 indicates the composition of the PCR mixture as suggested by Stratagene (Heidelberg, Germany).

Protein	Forward Primer	Reverse Primer
^{T40A} EAAT4	5' CGCTTGCGCCTGCAG GCCATGACCCGAGAGC 3'	5' CCCCAAGTACA TTGGCCATCGTAC GAAGTCG 3'
^{T504A} EAAT4	5' GCTCTCGGGTCATGG CCTGCAGGCGCAAGCG 3'.	5' CCCCAAGTACAT TGGCCATCGTACG AAGTCG 3'
^{S356D} SGK2	5' GCATTCCTGGGATTTG ATTATGCGCCAG AGG 3'.	5' CCTCTGGCGCAT AATCAAATCCCAGG AATGC 3'.
^{S419D} SGK3	5' GATGCATTCGTTGGTT TCGATTATGCACCTCCTT CAG 3'.	5' CTGAAGGAGGTG CATAATCGAAACCA ACGAATGCATC 3'.

Table 3 Forward and reverse primers used to generate ^{T40A}EAAT4, ^{T504A}EAAT4, ^{S356D}SGK2 and ^{S419D}SGK3.

PCR reaction mixture	Quantity
10 X reaction buffert	5 µl
dsDNA template	5-50 ng
Oligonucleotide primer 1	125 ng
Oligonucleotide primer 2	125 ng
dNTP mix	1 µl
Pfu Turbo DNA polymerase (2.5 U/ µl)	1 µl

Table 4 PCR reaction mixture used to generate ^{T40A}EAAT4, ^{T504A}EAAT4 and ^{T40AT504A}EAAT4 mutants.

5.1.1 Transformation of *E.coli* XL1-Blue Supercompetent Cells

E.coli XL1-Blue Supercompetent cells from Stratagene, (Heidelberg, Germany) were thawed on ice and 50 µl of the supercompetent cells were taken into a prechilled Falcon 2059 polypropylene tube. 1 µl of *Dpn* I-treated DNA sample was added to the aliquots of supercompetent cells. The tube was gently vortexed to mix the content and incubated on ice for 30 minutes. Transformation reaction was started by keeping the tube at 42°C for 45 seconds which make bacteria to open their pores on the cell wall to provide entry of DNA and then suddenly placed on ice for 2 minutes which allows bacteria to close the cell wall pores.

0.5 ml of preheated (42°C) NZY broth was added to the heat-shock treated supercompetent cells and incubated at 37°C for 1 hour with shaking at 220 rpm. Then 250 µl of DNA transformed bacterial cells were plated on agar plates. LB plates were incubated at 37°C overnight.

From LB plates several clones were picked and bacteria were grown in LB broth to get more quantity of bacterial cells to isolate transformed plasmids for further experiments. The mutant plasmids from *E.coli* cells were isolated and purified with Qiagen (Hilden, Germany) DNA plasmid midi purification kit according to the manufacturer's instructions. The purified plasmids were sequenced to confirm the desired mutation.

5.2 Preparation of cRNA

To study the function and expression of transporters, cRNAs of transporters were injected into *Xenopus laevis* oocytes. The mutant DNAs including EAAT2-HA, ^{T40A}EAAT4, ^{T504A}EAAT4 and ^{T40AT504A}EAAT4, were used as a template to synthesise cRNA. cRNAs of SGK and PKB kinases and Nedd4-2 were also synthesised by the same method. RNA synthesis protocol possesses two steps: linearization of the plasmid DNA containing the sequence of interest and generation of cRNA itself.

5.2.1 Plasmid DNA linearization

The restriction endonuclease was used to make a cut at the 3' end of the insert and to yield a 5' blunt end. Specific restriction enzymes used to linearize each plasmid used in this study are shown in Table 5.

Protein	Plasmid	Restriction Endonuclease
^{S422D} SGK1	pGHJ	<i>Not</i> I
SGK2 and SGK3	pGHJ	<i>Not</i> I
PKB	pGHJ	<i>Sal</i> I
human Nedd4-2, and ^{S382D.S468D} Nedd4-2	pGHJ	<i>Hind</i> III
^{C962S} Nedd4-2	pGHJ	<i>Bgl</i> II
human EAAT2-HA	pOTV	<i>Spe</i> I
rat EAAT4, EAAT4-HA, ^{T40A} EAAT4, ^{T504A} EAAT4 and ^{T40AT504A} EAAT4	pGHJ	<i>Xba</i> I
GLUT1	pSP64T	<i>Xba</i> I

Table 5 Plasmids containing desired gene encoding for specific proteins and restriction endonuclease enzymes used to linearize each plasmid.

The reaction mixture as mentioned in the table below was prepared and incubated at 37°C for 2 hours. Then DNA was precipitated with 1 volume of isopropanol (50 µl) and 1/10 volume of 3 M sodium acetate, pH 5.2 (5 µl) and incubated at room temperature for 10 minutes. Reaction mixture was centrifuged at 17000 rpm for 15 minutes at 4°C. After removing the supernatant, the pellet was washed twice with 70 % ethanol (100 µl) at 17000 rpm for 10 minutes. Ethanol was removed from the last wash and the pellet was dried using the Eppendorf Concentrator (Eppendorf, Hamburg, Germany) at 35-45°C for 5 minutes.

Reaction mixture	Quantity
10X Buffer	5 μ l
Plasmid DNA (10 μ g)	20 μ l
Restriction enzymed (20U)	2 μ l
Water	23 μ l

Table 6 Reaction mixture used to linearize plasmidic DNA.

5.2.2 cRNA synthesis

The linearized DNA produced from the above mentioned method was used as a template to generate cRNA. The reaction mixture given in table 7 was taken in a sterile eppendorf tube.

Reaction mixture	Quantity
Linearised DNA (1 μ g)	10 μ l
10 X Buffer	2.5 μ l
rNTPs	1 μ l
Cap analogue	2.5 μ l
RNase inhibitor	1 μ l
Water	8 μ l

Table 7 Reaction mixture used to synthesis RNA from the linearized DNA.

The reaction mixture was gently spanned and appropriate RNA polymerase (Table 8) was added and pulse spanned again. The reaction mixture was incubated at 37°C when using T3 or T7 polymerases or at 40°C when using SP6 polymerase for 1 hour. Then 1 μ l of Dnase was added to remove the possible DNA contamination in the reaction mixture. Finally reaction mixture was incubated at 37°C for 15 min by shaking.

Protein	RNA Polymerase	cRNA (ng/oocyte)
^{S422D} SGK1, ^{S356D} SGK2 and ^{S419D} SGK3	T7	7.5
PKB	T7	7.5
human Nedd4-2, ^{C962S} Nedd4-2 and ^{S382D.S468D} Nedd4-2	Sp6	12.5
human EAAT2-HA	T7	10
rat EAAT4, EAAT4-HA, ^{T40A} EAAT4, ^{T504A} EAAT4 and ^{T40AT504A} EAAT4	T7	10
Glut1	Sp6	1

Table 7 RNA polymerases used to prepare cRNA and amount of cRNA injected into oocytes.

To purify the generated RNA, 100 μ l DEPC water and 125 μ l of phenol-chloroform mixture was added and centrifuged at maximum speed for 2 minutes. The upper inorganic phase was carefully taken into a new eppendorf tube and 12.5 μ l of 3 M sodium acetate (pH 5.2) and 375 μ l of 100% ethanol was added and mixed by pulse vortex and further incubated at -70 $^{\circ}$ C overnight.

After incubation, the mixture was centrifuged at 17000 rpm for 15 minutes at 4 $^{\circ}$ C. The supernatant was removed and the pellet was washed twice with 200 μ l of 70% ethanol. Finally the pellet was dried at room temperature and reconstituted in 25 μ l of DEPC water and vortexed. Then concentration of RNA was measured by taking 1 μ l of RNA in 69 μ l water using an Eppendorf Biophotometer (Hamburg, Germany). The quality of the RNA generated was checked by gel electrophoresis.

5.3 *Xenopus laevis* oocyte preparation

Xenopus laevis oocytes were used as an expression system to study function and plasma membrane abundance of transporters. Prior to isolation of oocytes, female *Xenopus laevis* frogs were anaesthetized by submersion in a 0.1%

3-aminobenzoic acid ethyl ester solution (Sigma, St. Louis, Mo, USA) for 15-20min and placed on ice for surgery. Through a small abdominal incision (1-2 cm in length) small pieces of ovary were removed carefully without injuring any blood capillaries and the wound was subsequently closed with a reabsorbable suture. Frogs were kept wet but not under water until reflexes were fully recovered to prevent drowning.

The ovarian sacs were manually tore apart and oocytes were separated with fine tweezers in OR2 solution (82.5 mM NaCl, 2 mM KCl, 1mM MgCl₂ and 5 mM HEPES (4-(2-hydroxyethyl)-1-piperazineethanesulfonic acid), pH 7.5). Enzymatic defolliculation was achieved by treatment of ovarian lobes with OR2 solution with 1 mg/ml collagenase (Biochrom, Berlin, Germany) for about 60-120 min at room temperature. The flask was slightly shaken to ensure even digestion.

To stop defolliculation, oocytes were repeatedly washed with ND96 (96 mM NaCl, 2 mM KCl, 1.8 mM CaCl₂, 1 mM MgCl₂, and 5 mM HEPES, pH 7.65) to remove all detritus and collagenase. Large oocytes (stage V-VI) showing evenly coloured poles and a sharp border between both poles were selected and stored overnight in a ND96 storage solution (complemented after sterilisation with 5 mM pyruvate, 50 µg/ml gentamycin and 0.5 mM theophylline) at 15 °C. Gentamycin helps preventing infections and theophylline inhibits the further maturation of the oocytes. Figure 9 depicts oocyte preparation and cRNA injection.

Oocytes preparation and injection

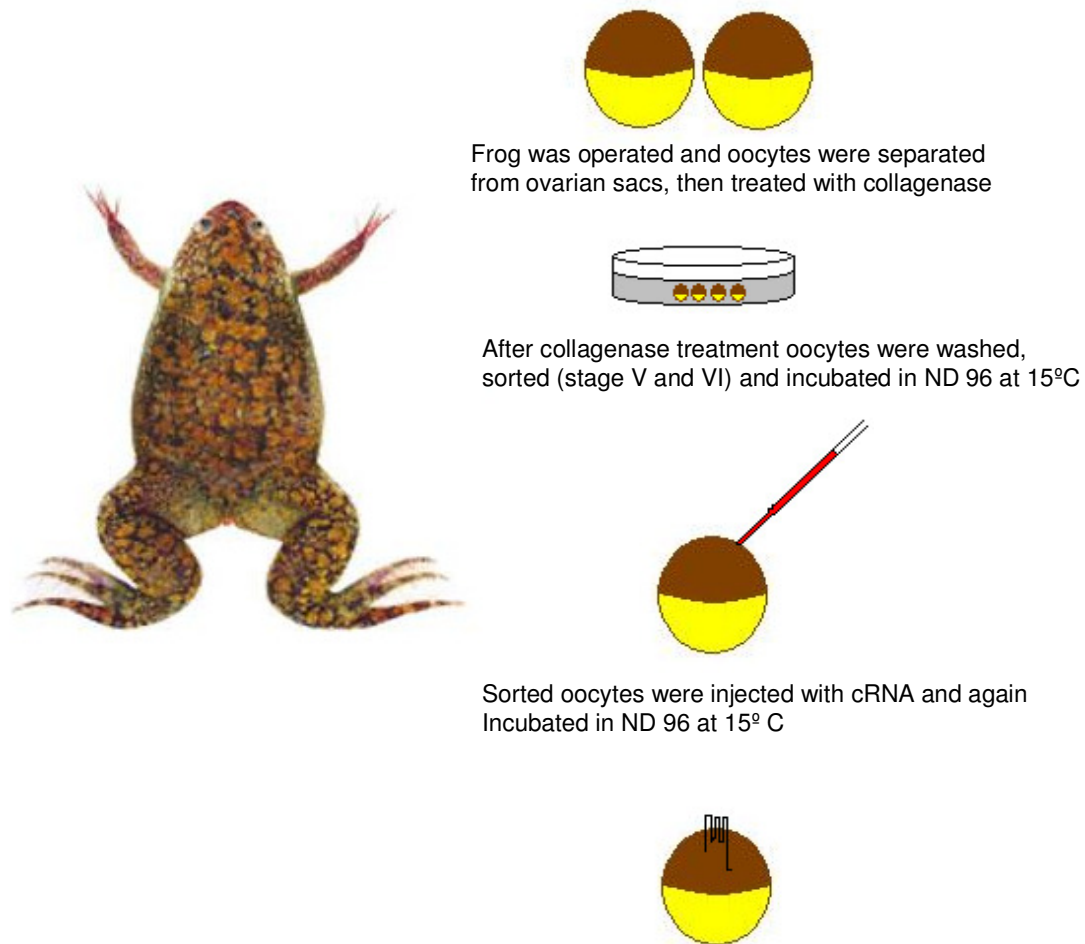

Figure 9 An overall view of oocytes preparation, cRNA injection and protein expression in oocytes.

5.4 Protein expression in *Xenopus laevis* oocytes

Oocytes were injected with kinases ^{S422D}SGK1, ^{S356D}SGK2, ^{S419D}SGK3 and ^{T308D, S473D}PKB cRNA and/or wild type or mutated Nedd4-2 cRNA or H₂O on the first day after preparation of the oocytes and subsequently with EAAT2-HA, EAAT4 or its mutant cRNAs next day. For RNAi, experiments 1.5 ng of double-stranded siRNA 19-mer oligo (Invitrogen Corporation, Carlsbad, California, USA) corresponding to bases 2707-2725 of xNedd4-2 was injected into oocytes on the first day and then next day oocytes were injected with ^{S422D}SGK1 and EAAT4-HA in two hours interval.

On the fifth day of kinase injection tracer uptake measurement was carried out to study the activity of the transporters. On the same day chemiluminescence assay was performed to study the plasma membrane abundance of the transporters. Oocytes were lysed and proteins isolated to perform western blotting to address proper protein expression and assessment of RNAi gene silencing at the protein level.

5.5 *Nedd4-2* RNA Silencing by siRNA

The indirect mechanism of EAAT4 stimulation by SGK1 through inhibiting the downregulating effect of Nedd4-2 could be analysed by silencing Nedd4-2 of *Xenopus* oocytes. The small interfering RNA (siRNA) technique was employed to silence the intrinsic Nedd4-2. Using Ambion[®] siRNA Target Finder, siRNA for Nedd4-2 was designed online. Chosen siRNA corresponds to bases 2707-2725 of xNedd4-2 within is the catalytically active region. Chemically synthesized Nedd4-2 siRNA was bought from Invitrogen Corporation (Carlsbad, California, USA). Figure 10 depicts siRNA mode of action. The silencing activity of siRNA starts with the introduction of a long piece of double stranded RNA (dsRNA) into the eukaryotic cell. In the natural pathway, the dsRNA is sliced into smaller pieces by an enzyme named 'dicer'. The small pieces of RNA are called small interference RNA (siRNA) which complex with a number of proteins and form RNA-induced silencing complex (RISC). RISC unwinds siRNA into single strand and thereby RISC-siRNA complex targets mRNA. The targeted mRNA hybridizes with and is degraded by the siRNA.

Short interfering RNA (siRNA)

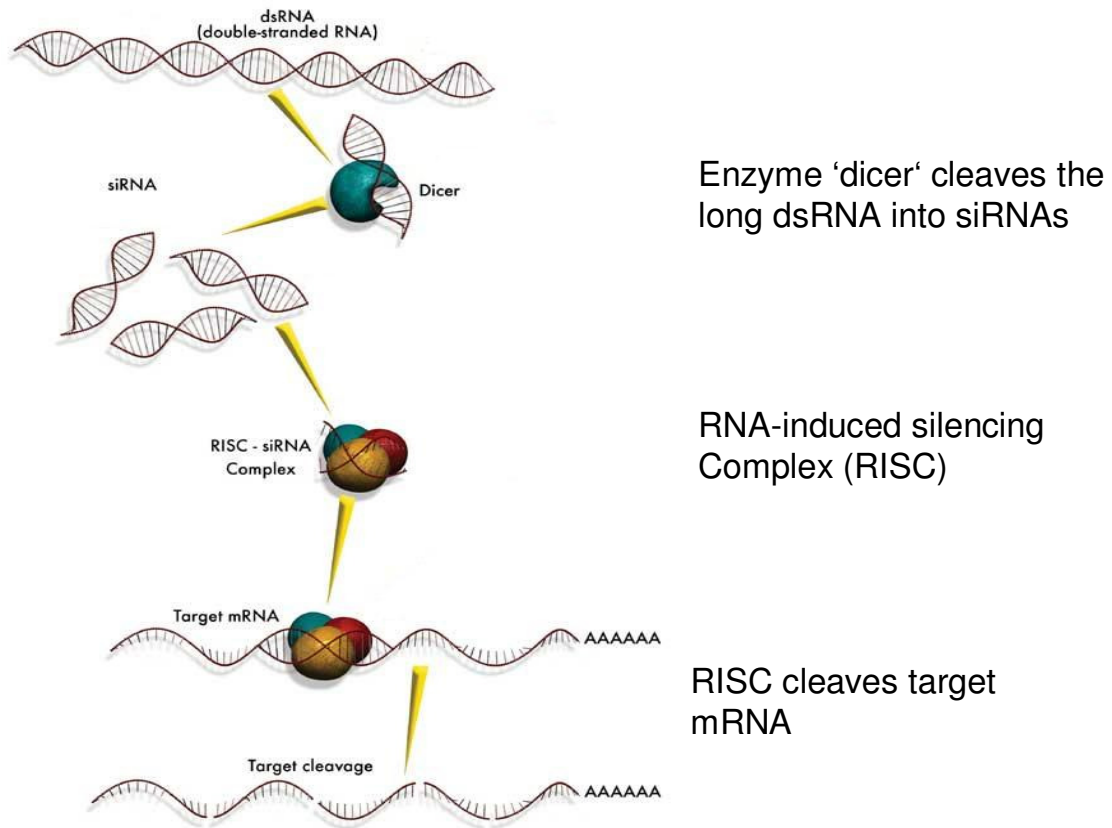

Figure 10 Schematic representation of siRNA mode of action.

1.5 ng of double-stranded siRNA 19-mer oligo was injected into oocytes on the first day after oocytes' preparation and EAAT4 and/or SGK1 was injected on the following day. On the fifth day of the injection tracer flux measurement was done to observe the activity of the transporter coexpressed with siRNA and/or with SGK1. For the assessment of RNAi gene silencing at the protein level, oocytes were lysed on the same day that functional experiments were performed and western blotting was carried out as described below.

5.6 Tracer Flux Measurements

Function of the transporters was demonstrated by means of tracer flux measurements. The transport assay was performed on the fifth day after cRNA

injection. 5-10 single oocytes were incubated in 500 μ l of ND96-Na (96 mM NaCl, 2 mM KCl, 1.8 mM CaCl₂, 1 mM MgCl₂ and 5 mM HEPES, pH 7.65) containing 1 μ Ci [³H] L-glutamate and 10 μ M of unlabelled L-glutamate and another set with the same number of oocytes were incubated in ND96-Ch (96 mM ChCl, 2 mM KCl, 1.8 mM CaCl₂, 1 mM MgCl₂ and 5 mM HEPES, pH 7.65) where NaCl was substituted by choline chloride (ChCl).

After incubation for 10 minutes with L-glutamate (linear range of uptake), uptake was terminated by washing the oocytes four times with 3 ml of ice-cold ND96-Na and ND96-Ch containing 1 mM unlabelled L-glutamate. Oocytes were individually transferred into scintillation vials and dissolved by adding 200 μ l of 10% SDS before the radioactivity was determined. Uptake values obtained with ND96-Ch were always subtracted from the values obtained with ND96-Na, because EAAT2 and EAAT4 are sodium dependent glutamate transporters which uptake glutamate with influx of two to three sodium ions and one proton with efflux of one potassium ion.

For determination of GLUT1 activity, tritium-labeled 2-deoxy-D-glucose ([³H] 2-DOG) was used as the glucose analogue. The GLUT1 transport assay was performed 4 days after cRNA injection and contained 5-10 single oocytes in 0.25 ml of ND96 (96 mM NaCl, 2 mM KCl, 1.8 mM CaCl₂, 1 mM MgCl₂ and 5 mM HEPES, pH 7.4) containing 1 μ Ci of [³H] 2-DOG and 50 μ M of unlabelled 2-DOG. After incubation for 30 min at room temperature with 2-DOG (linear range of uptake), uptake was terminated by washing the oocytes four times with 3 ml of ice-cold ND96. Oocytes were individually transferred into scintillation vials and dissolved by adding 200 μ l of 10% SDS before the radioactivity was determined.

5.7 Detection of Cell Surface Expression by Chemiluminescence

To quantify abundance of the transporters expressed on the plasma membrane of oocytes, chemiluminescence assay was employed. On the fifth day of kinase injection oocytes were incubated in 400 μ l of ND96 with 1% BSA solution for 20 min at room temperature as a blocking step. Oocytes were then incubated with 1

$\mu\text{g/ml}$ primary rat monoclonal anti-HA antibody (clone 3F10, Boehringer, Germany), which can detect the haemagglutinin tag inserted into the extracellular loops of EAAT2 and EAAT4 in 200 μl of ND96 with 1%BSA solution.

After an hour of incubation at room temperature, oocytes were washed with 400 μl of ND96 with 1% BSA for 5 times in 30 minutes. 2 $\mu\text{g/ml}$ secondary, peroxidase-conjugated affinity-purified F(ab')₂ goat anti-rat IgG antibody (Jackson ImmunoResearch, West Grove, USA) was added to oocytes in 200 μl of ND96 with 1% BSA and incubated for 1 hour. Oocytes were again washed with 400 μl of ND96 with 1% BSA for 10 times in one hour. Finally oocytes were washed with 400 μl of ND96 alone for 3 times in 15 min.

Individual oocytes were placed in 96 well plates with 100 μl of ND96 and 20 μl of SuperSignal ELISA Femto Maximum Sensitivity Substrate (Pierce, Rockford, USA), was added to each well. Chemiluminescence was quantified in a luminometer (Wallac Victor 2 plate reader, Perkin Elmer, Juegesheim, Germany) by integrating the signal over a period of 1 second. Results are given in relative light units (RLU).

RLU obtained with H₂O-injected oocytes (control oocytes) were subtracted from the values obtained with oocytes injected with EAAT2-HA and EAAT4-HA alone or together with the respective SGK isoforms and/or Nedd4-2. In the relevant range of protein expression, the chemiluminescence amplitude correlates linearly with the protein abundance at the cell membrane¹⁷⁵. Figure 11 shows an overview of the performed cell surface assay.

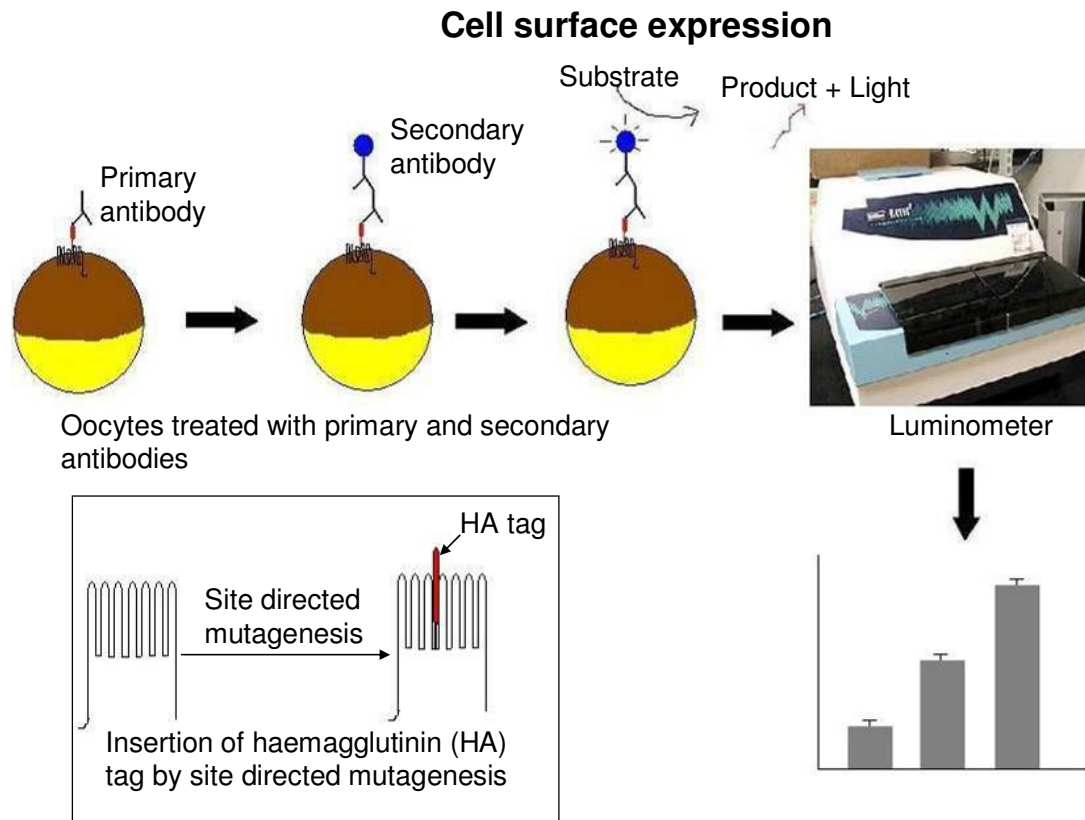

Figure 11 Overall view of a chemiluminescence-based cell surface experiment.

5.8 Western Blotting

The expression of SGK1, Nedd4-2 and GAPDH was analyzed by western blotting. Briefly, oocytes were homogenized in lysis buffer containing 50 mM Tris (pH 7.5), 0.5 mM EDTA (pH 8.0), 0.5 mM EGTA, 100 mM NaCl, 1 % Triton X-100, 100 μ M sodium orthovanadate and protease inhibitor cocktail (Roche, Mannheim, Germany) at the recommended concentration.

Proteins were separated on an 8 % polyacrylamide gel and transferred to nitrocellulose membranes. After blocking with 5 % non-fat dry milk in PBS / 0.15 % Tween 20 for 1h at room temperature, blots were incubated overnight at 4°C with a rabbit Nedd4-2 antibody (diluted 1:1000 in PBS / 0.15 % Tween 20 / 5 % non-fat dry milk), a rabbit anti-SGK1 antibody (Upstate, Waltham, MA, USA, diluted 1:1000 in PBS / 0.15 % Tween 20 / 5 % non-fat dry milk) or a rabbit anti-GAPDH HRP conjugated antibody (Santa Cruz Biotechnology, Heidelberg, Germany, diluted 1:1000 in PBS / 0.15 % Tween 20 / 5 % non-fat dry milk). GAPDH was used to demonstrate equal amount of protein loading. Secondary peroxidase-conjugated

sheep anti-rabbit IgG (diluted 1:1000 in PBS / 0.15 % Tween 20 / 5 % non-fat dry milk) were used for chemiluminescent detection with enhanced chemiluminescent ECL kit (Amersham, Freiburg, Germany). Band intensities were quantified using Quantity One® Analysis software (Biorad, Munich, Germany).

5.9 Statistical Analysis

Data are provided as means \pm SEM, n represents the number of oocytes investigated. All experiments were repeated with at least 3 batches of oocytes; in all repetitions qualitatively similar data were obtained. All data were tested for significance using ANOVA, and only results with $P < 0.05$ were considered as statistically significant.

6 Results

6.1 Modulation of EAAT2 by SGK1-3 and PKB

6.1.1 SGK1 stimulates EAAT2 activity and plasma membrane abundance

To evaluate the role of SGK1 in EAAT2 regulation, the transporter was expressed in *Xenopus laevis* oocytes in the absence and presence of the kinase and [³H] L-glutamate uptake was determined as a measure of EAAT2 activity. ^{S422D}SGK1-mediated glutamate uptake increased upon coexpression of SGK1 (from 1.94 ± 0.38 pmol/10 min/oocyte in EAAT2-HA expressing oocytes to 3.52 ± 0.32 pmol/10 min/oocyte in oocytes coexpressing EAAT2-HA with ^{S422D}SGK1, n= 22) (Figure 12). Increased EAAT2 activity could be caused by enhanced expression of the transporter in the plasma membrane. To determine EAAT2 plasma membrane abundance we performed chemiluminescence assays by using an anti-HA antibody that recognizes an HA tag placed in an extracellular loop within the EAAT2 sequence (EAAT2-HA). Data obtained demonstrate that ^{S422D}SGK1 stimulates EAAT2 plasma membrane expression up to two fold (n= 35-37, Figure 13).

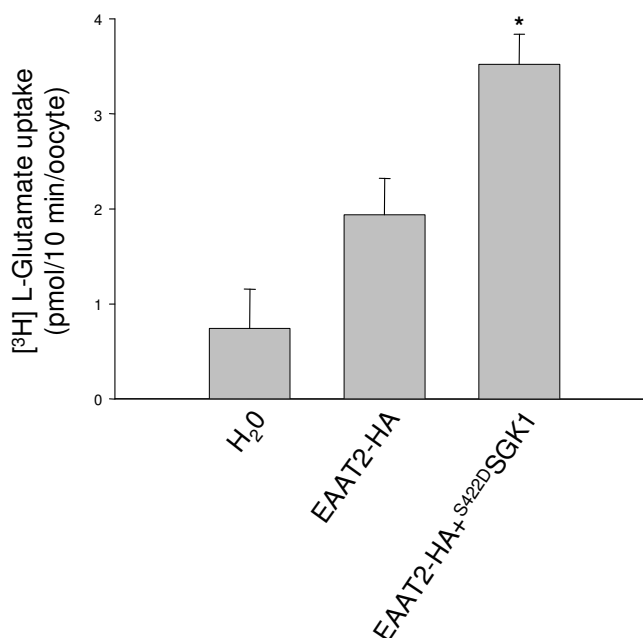

Figure 12 ^{S422D}SGK1 stimulates the activity of EAAT2-HA when coexpressed in *Xenopus laevis* oocytes. Arithmetic means \pm SEM. * indicates statistically significant difference to uptake in *Xenopus* oocytes expressing EAAT2-HA alone. n= 21-23.

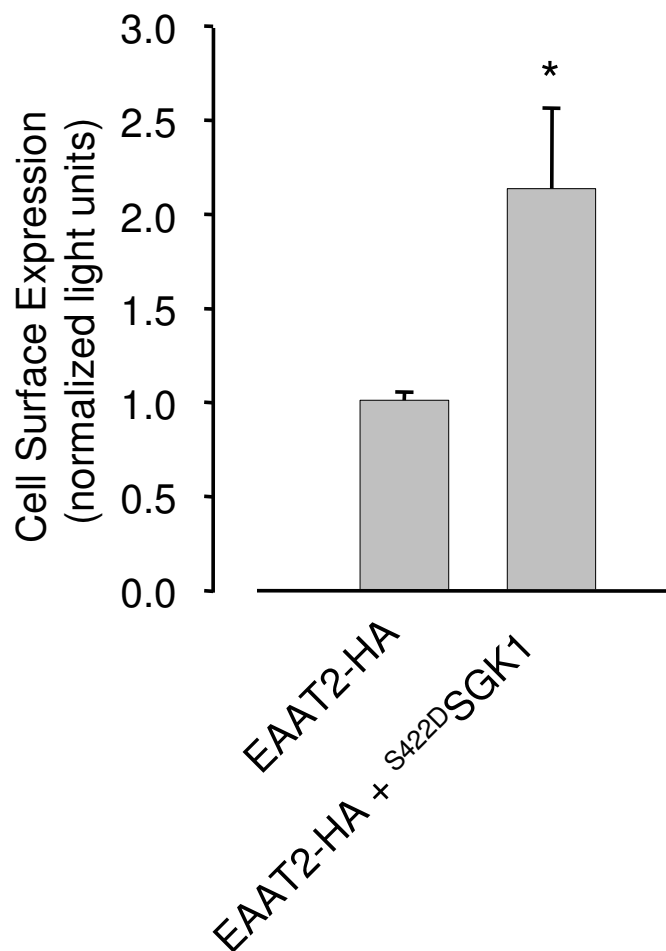

Figure 13 SGK1 stimulates the plasma membrane abundance of EAAT2-HA when coexpressed in *Xenopus laevis*. Arithmetic means \pm SEM. * indicates statistically significant difference to the EAAT2 abundance in *Xenopus* oocytes expressing EAAT2-HA alone. n= 35 - 37.

6.1.2 SGK1 isoforms SGK2-3 and PKB similarly stimulate Nedd4-2 plasma membrane abundance

To explore whether the SGK1 isoforms (SGK2-3) and PKB are also able to increase glutamate transport mediated by EAAT2, the different constitutively active SGK kinase isoforms were coexpressed with the transporter and labelled glutamate uptake was measured. Figure 14 shows that ^{S356D}SGK2 and ^{S419D}SGK3 upregulate EAAT2 as well (from 1.94 ± 0.38 pmol/10 min/oocyte in EAAT2-HA expressing oocytes to 4.72 ± 0.54 pmol/10 min/oocyte and 5.99 ± 0.87 pmol/10 min/oocyte in oocytes coexpressing EAAT2-HA with ^{S356D}SGK2 and ^{S419D}SGK3 respectively, n= 23). We also quantified cell surface expression of the carrier in the presence of

^{S356D}SGK2 and ^{S419D}SGK3. As demonstrated in Figure 15, carrier abundance in the oocyte membrane was similarly upregulated up to 2.3 fold by ^{S356D}SGK2, ^{S419D}SGK3 and ^{T308D, S473D}PKB (n= 35-37).

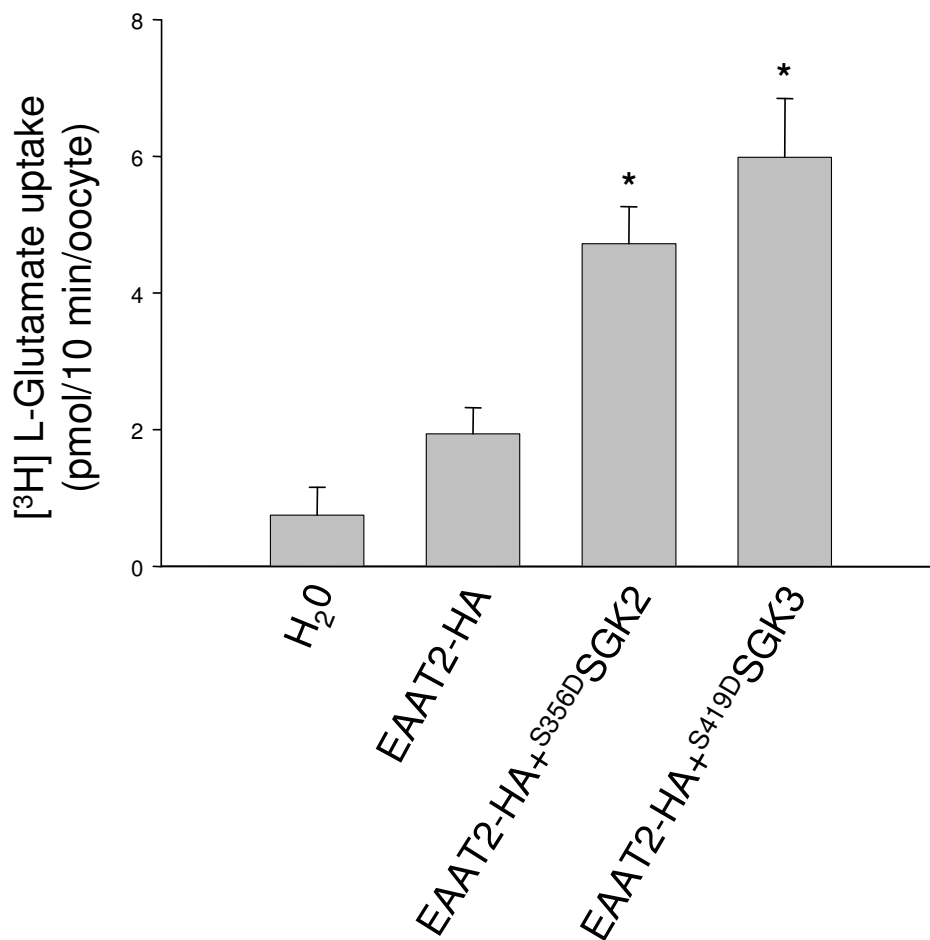

Figure 14 ^{S356D}SGK2 and ^{S419D}SGK3 enhance the activity of EAAT2-HA when coexpressed in *Xenopus laevis* oocytes. Arithmetic means \pm SEM. * indicates statistically significant difference to uptake in *Xenopus* oocytes expressing EAAT2-HA alone. n= 23.

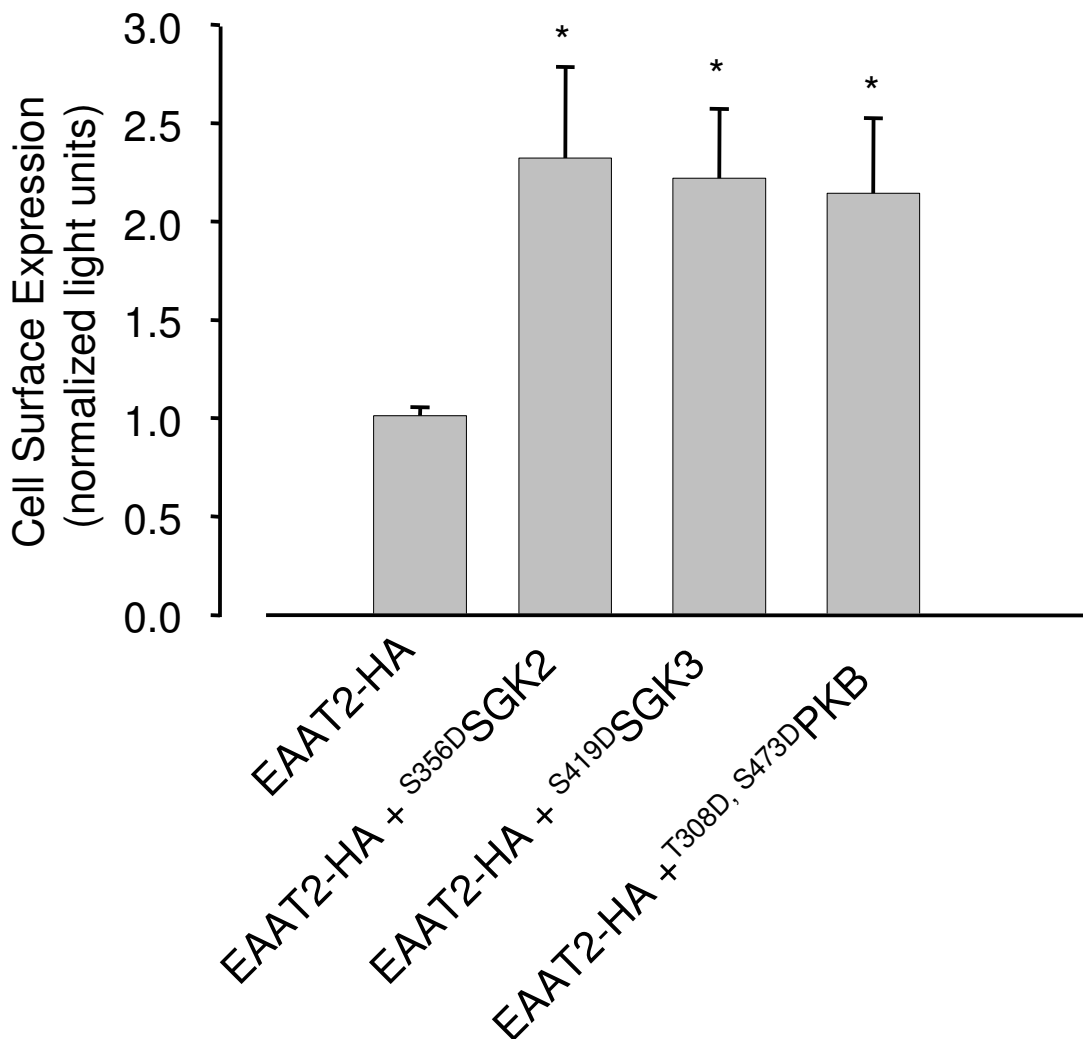

Figure 15 ^{S356D}SGK2 and ^{S419D}SGK3 increase the plasma membrane abundance of EAAT2-HA when coexpressed in *Xenopus laevis* oocytes. * indicates statistically significant difference to the EAAT2 surface abundance in *Xenopus* oocytes expressing EAAT2-HA alone. n= 35-37.

6.1.3 SGK1 enhances EAAT2 by inhibiting Nedd4-2 effects without altering Nedd4-2 expression

EAAT2 does not bear any putative SGK1 phosphorylation site on its sequence, thus the transporter cannot be directly enhanced by the kinase. In order to test whether SGK1 is effective through inhibition of the ubiquitin ligase Nedd4-2, we analyzed the impact of several Nedd4-2 mutants on EAAT2 activity. We used a catalytically inactive ^{C962S}Nedd4-2 and a Nedd4-2 mutant that mimics the phosphorylation state of Nedd4-2 when expressed with SGK1 (^{S382D, S468D}Nedd4-2). Both sites (S382D, S468D) have been shown to be phosphorylated by SGK1 and in

the context of ENaC regulation by Nedd4-2, phosphorylation at these sites prevents Nedd4-2 binding to ENaC⁶⁰. We therefore evaluated whether ^{C962S}Nedd4-2 and ^{S382D, S468D}Nedd4-2 were capable to influence EAAT2 activity. As shown in Figure 16, both mutants failed to modulate EAAT2 (from 2.09 ± 0.89 pmol/10 min/oocyte in EAAT2-HA expressing oocytes to 1.89 ± 0.63 pmol/10 min/oocyte and 3.09 ± 1.50 pmol/10 min/oocyte in oocytes coexpressing EAAT2-HA with ^{C962S}Nedd4-2 and ^{S382D, S468D}Nedd4-2 respectively, n= 22). Additional expression of ^{S422D}SGK1 augmented the transporter activity (from 2.09 ± 0.89 pmol/10 min/oocyte in EAAT2-HA expressing oocytes to 3.01 ± 0.69 pmol/10 min/oocyte in oocytes coexpressing EAAT2-HA with ^{S382D, S468D}Nedd4-2 and ^{S422D}SGK1, n= 22). Thus, the kinase stimulates EAAT2 at least by indirectly inhibiting the ubiquitin ligase Nedd4-2.

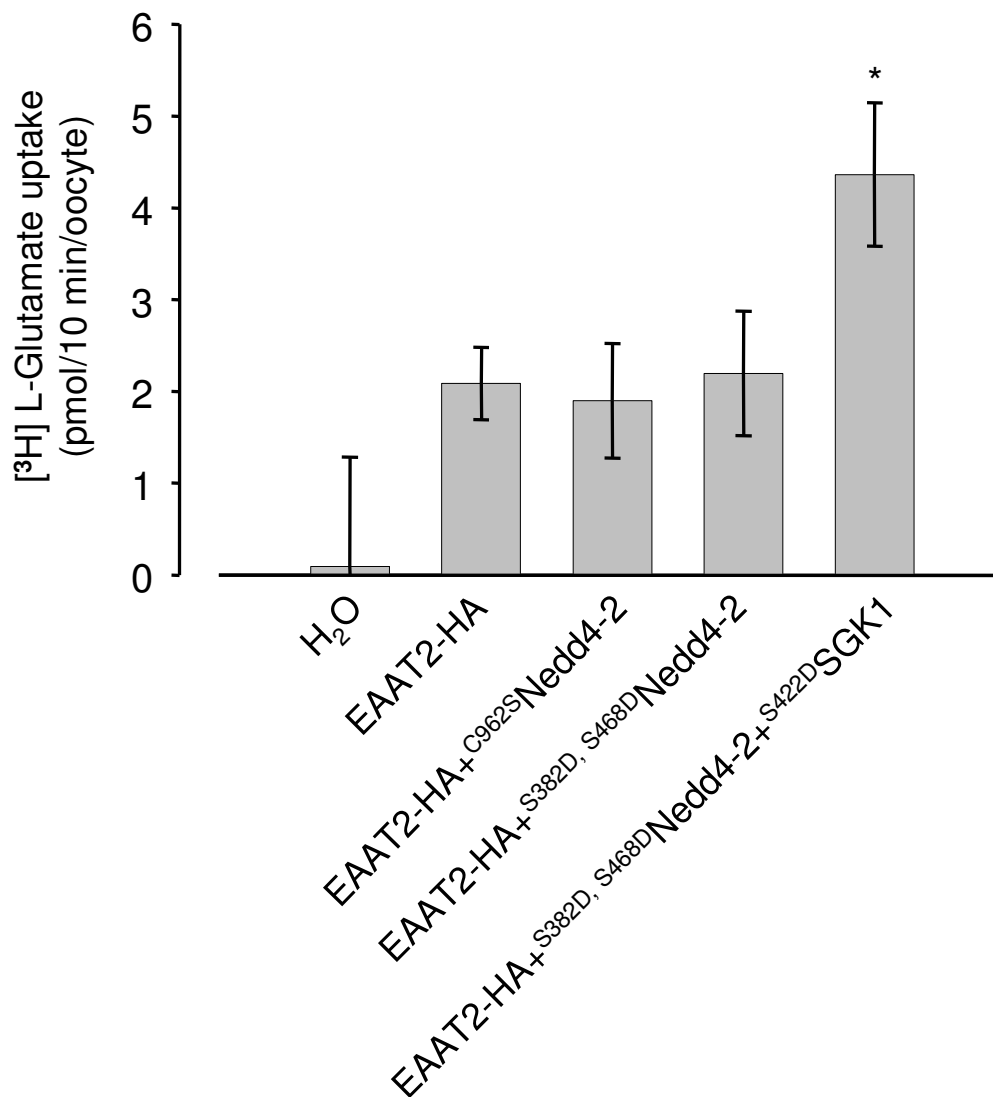

Figure 16 SGK1 promotes EAAT2-HA activity indirectly through inhibiting the ubiquitin ligase Nedd4-2. Neither the Nedd4-2 mutant mimicking its phosphorylation state by SGKs (^{S382D, S468D}Nedd4-2) nor the mutant ^{C962S}Nedd4-2 bearing a destructed catalytic domain modify [³H] – L-glutamate uptake. * indicates statistically significant difference to glutamate uptake in oocytes expressing EAAT2-HA alone n= 22.

Coexpression of SGK1 could impact EAAT2 activity and expression. To rule out the possibility that SGK1 inhibits Nedd4-2 by downregulating Nedd4-2 expression, western blots were performed. According to immunoblotting Nedd4-2 protein abundance was unaffected upon coexpression of ^{S422D}SGK1 (Figure 17). The SGK1 isoforms, SGK2-3, were also unable to modulate Nedd4-2 expression. Thus, SGKs impact Nedd4-2 activity while leaving Nedd4-2 levels unaffected.

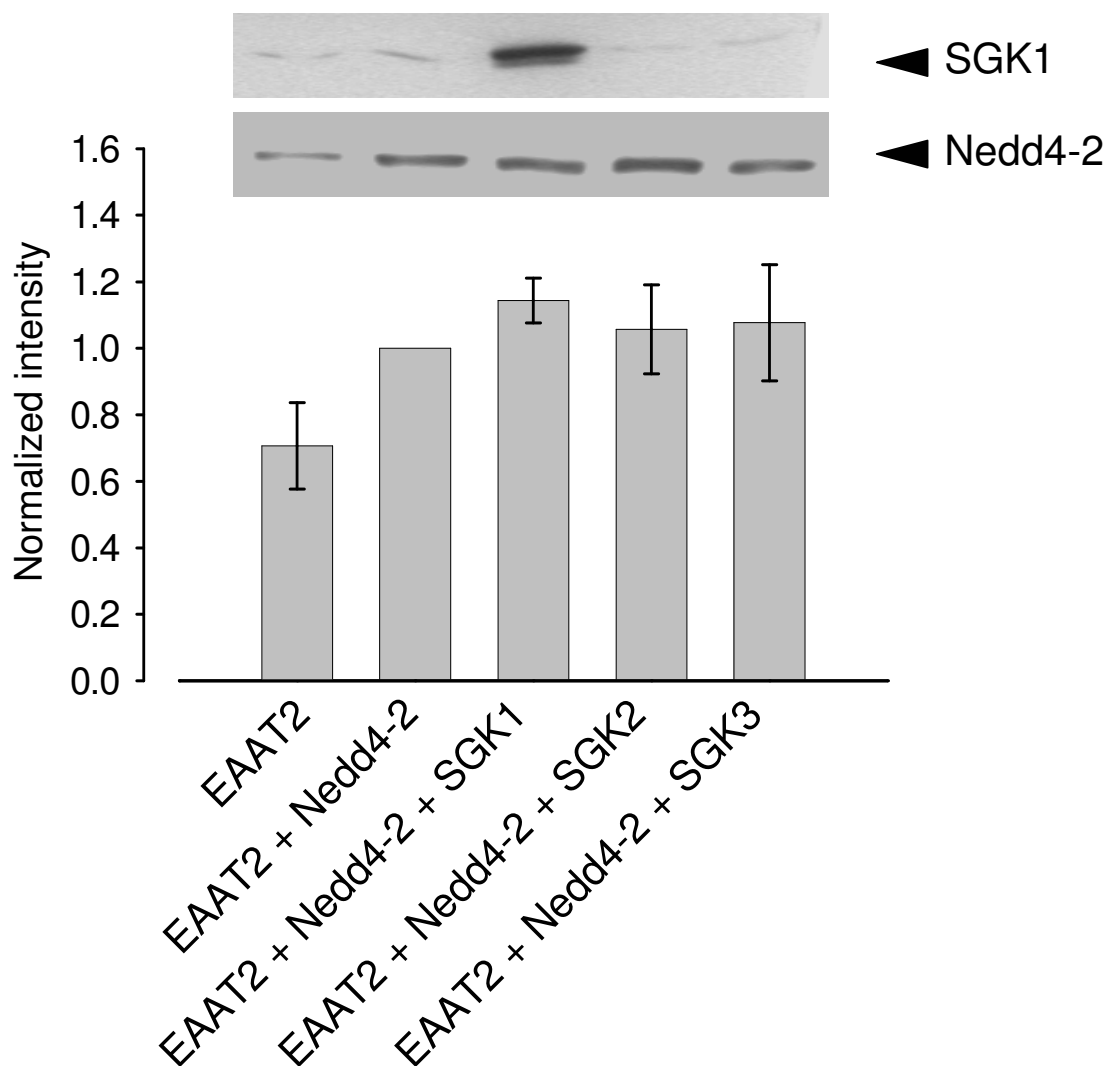

Figure 17 SGK1-3 expression in oocytes does not affect the expression levels of Nedd4-2. The histogram depicts the quantification of the Nedd4-2 band intensities from three different western blots. All data were normalized to cells expressing EAAT2 + Nedd4-2. Arithmetic means \pm SEM.

SGK1 contains a PY motif, a target structure that is recognized by Nedd4-2. Thus, Nedd4-2 could bind to and ubiquitinate the protein kinase, preparing it for degradation by the proteasome. To clarify whether Nedd4-2 downregulates SGK1 expression, the ubiquitin ligase was coinjected with SGK1 at different concentrations and SGK1 expression was analyzed by western blotting (Figure 18). SGK1 band intensities quantification demonstrated that Nedd4-2 does not significantly alter SGK1 expression.

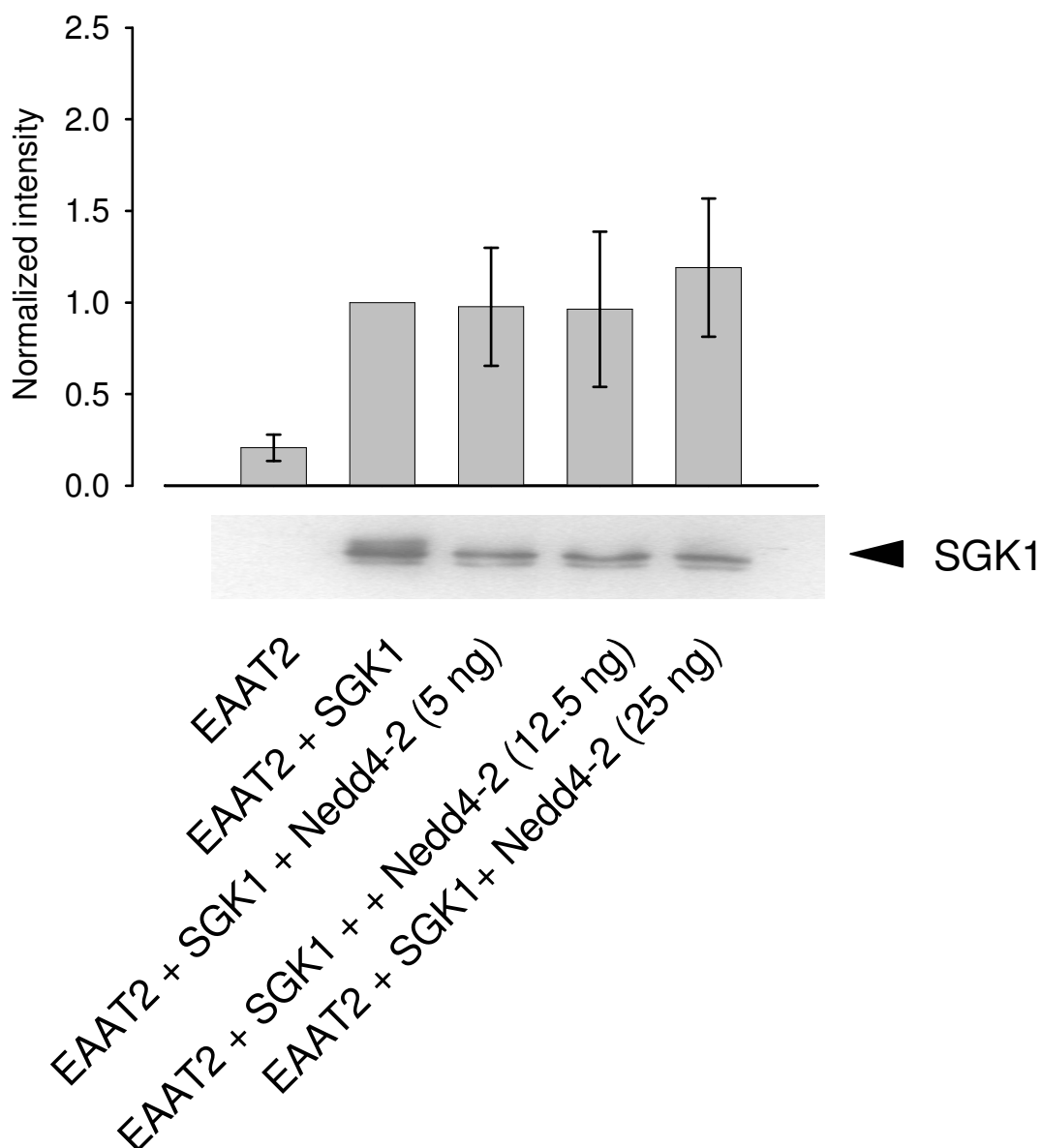

Figure 18 SGK1 expression remains unaltered upon Nedd4-2 overexpression. Immunoblots with a specific SGK1 antibody showed that expression of the kinase is not modulated by the ubiquitin ligase Nedd4-2. The histogram depicts the quantification of the SGK1 band intensities from three different western blots. All data were normalized to cells expressing EAAT2 + SGK1. Arithmetic means \pm SEM.

6.2 Modulation of EAAT4 by SGK1

6.2.1 SGK1 enhances EAAT4 mediated glutamate transport

In order to investigate the mechanism of EAAT4 activity modulation by SGK1, EAAT4 was expressed in *Xenopus laevis* oocytes and glutamate transport measured in the presence and absence of constitutively active ^{S422D}SGK1. On the

fifth day of kinase cRNA injection, labelled L-glutamate uptake was studied as a measure of EAAT4 activity.

Tracer-flux studies revealed an increase in EAAT4 transport rate (223.132 ± 41.17 % of control, $n = 18$, Figure 19) upon coexpression of ^{S422D}SGK1. Glutamate uptake into water injected oocytes was less than 42.41 ± 18.55 % of control ($n=21$).

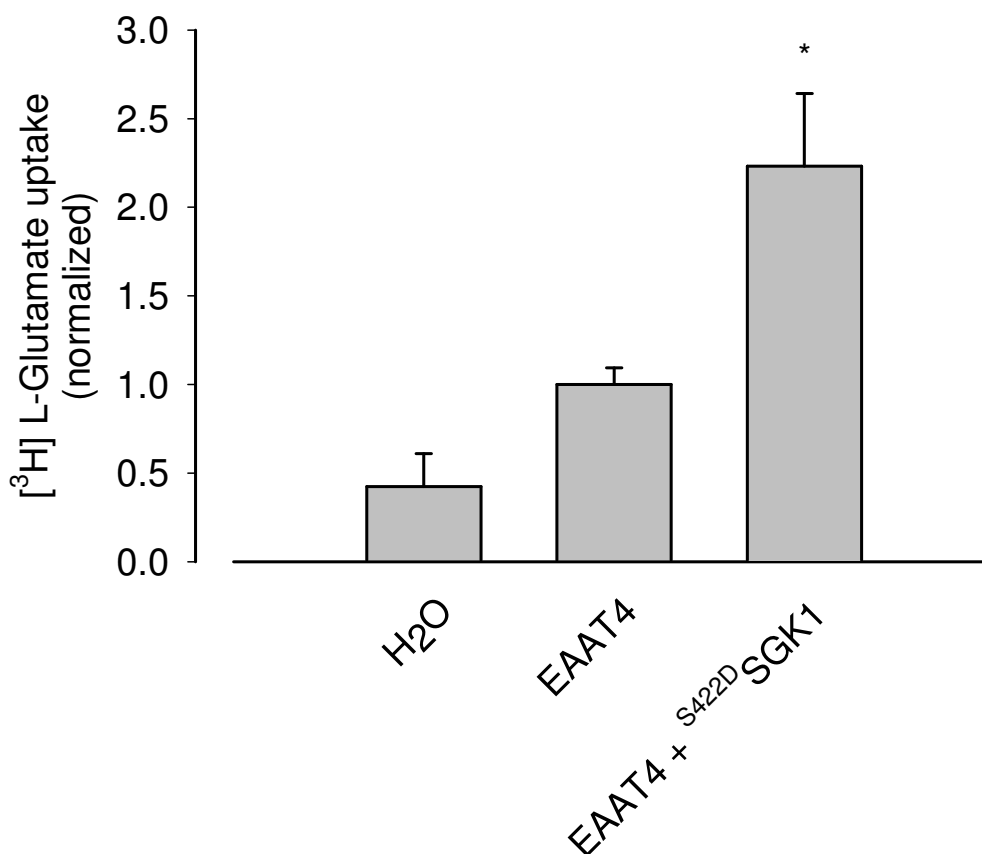

Figure 19 SGK1 expression in EAAT4-injected oocytes enhances the activity of EAAT4. Arithmetic means \pm SEM. * indicates statistically significant difference to uptake in *Xenopus* oocytes expressing EAAT4 alone. Uptake values were normalized in each batch of oocytes to the mean value obtained in oocytes expressing EAAT4 alone. $n=21$.

6.2.2 Disruption of the putative SGK1 phosphorylation sites (Thr40 and Thr504) on EAAT4 abrogates transporter stimulation

EAAT4 contains two putative SGK1 phosphorylation sites on its sequence at Thr40 and Thr504 present at the cytosolic amino and carboxy termini, respectively. Both sites are highly conserved among species including human, mouse and rat

and thus suggests an important role of these residues in EAAT4 function and regulation. To determine whether SGK1 modulates EAAT4 uptake by phosphorylating EAAT4 directly, threonine at positions 40 and 504 in EAAT4 were mutated into alanine (^{T40AT504A}EAAT4) by site-directed mutagenesis and its regulation evaluated upon coexpression of the kinase. Threonine replacement eliminates the putative phosphorylation site of SGK1 (Arg-Xaa-Arg-Xaa-Xaa-Ser/Thr) on EAAT4, thus hypothetically SGK1 cannot act on that site.

Xenopus oocytes were injected with wild-type EAAT4 or phosphorylation-deficient ^{T40AT504A}EAAT4 alone or together with constitutively active ^{S422D}SGK1. On the fifth day of injection, labelled L-glutamate uptake was studied and western blotting of whole cell lysates performed. Disruption of the putative SGK1 phosphorylation sites abrogated EAAT4 stimulation by ^{S422D}SGK1 (from 77.31 ± 13.23 % of control, n = 23, in ^{T40AT504A}EAAT4 expressing oocytes to 63.23 ± 10.80 % of control, n = 22, in oocytes expressing ^{T40AT504A}EAAT4 along with ^{S422D}SGK1), suggesting that the kinase is effective through direct EAAT4 phosphorylation (Figure 20).

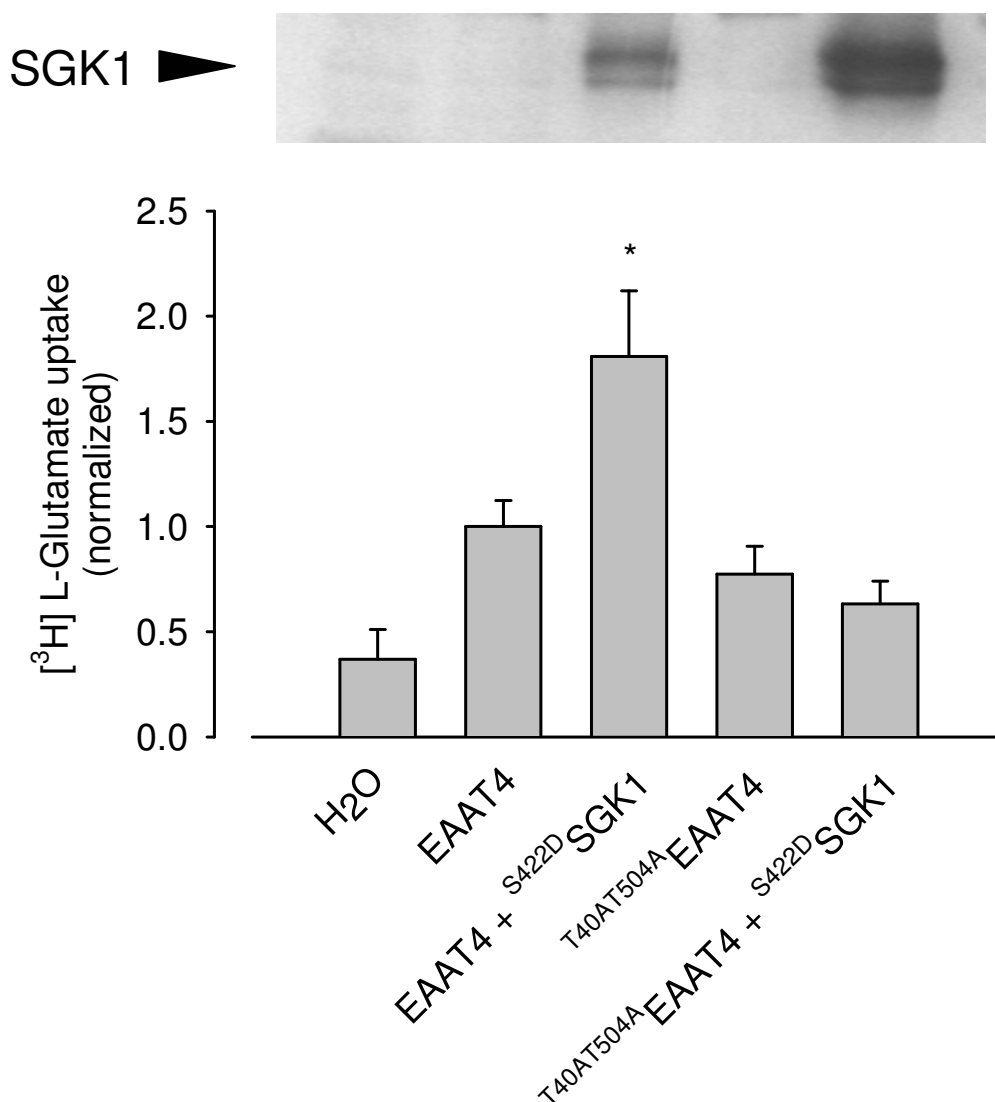

Figure 20 Mutant EAAT4 (^{T40A}^{T504A}EAAT4) with disrupted SGK1 phosphorylation sites failed to be stimulated by ^{S422D}SGK1. Proper ^{S422D}SGK1 expression was checked by western blotting. Arithmetic means \pm SEM. * indicates statistically significant difference to uptake in *Xenopus* oocytes expressing wild-type EAAT4 alone. Uptake values were normalized to the mean value obtained in oocytes expressing wild-type EAAT4 alone. n = 22-23.

6.2.3 Phosphorylation at Thr40 on EAAT4 is essential for transporter stimulation

To delineate whether a unique or both phosphorylation sites are required for enhanced EAAT4 activity, single phosphorylation-deficient mutants were generated. The cRNAs of wild-type EAAT4, ^{T40A}EAAT4 or ^{T504A}EAAT4 alone or together with constitutively active ^{S422D}SGK1 were expressed in *Xenopus*

oocytes and on the fifth day of injection, labelled L-glutamate uptake was studied and western blotting of whole cell lysates performed. Coexpression of ^{S422D}SGK1 with ^{T504A}EAAT4 promoted the transporter's activity (from 100.51 ± 20.91 % of control, n = 9 to 192.71 ± 26.27 % of control, n = 9), whereas expression of the kinase failed to modulate ^{T40A}EAAT4 function despite normal SGK1 expression levels as assessed by western blotting of whole cell lysates (Figure 21).

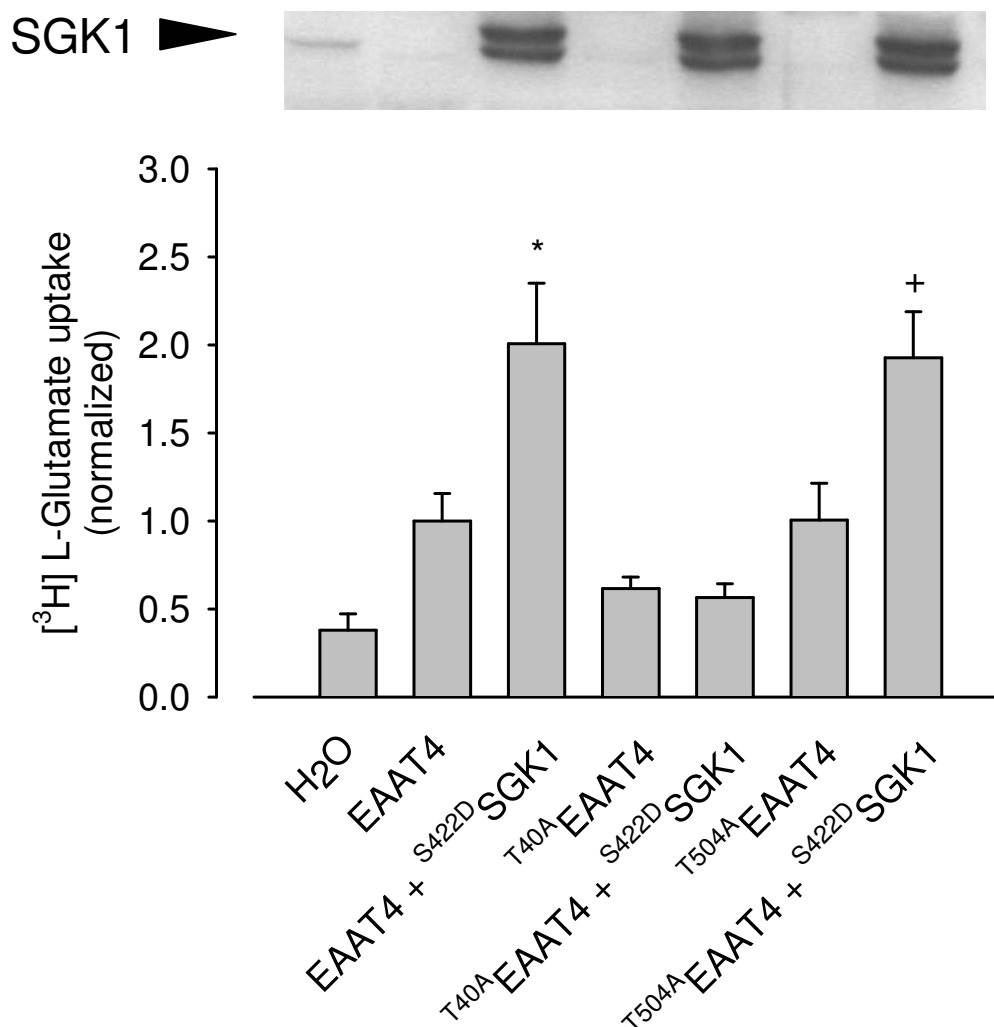

Figure 21 Upon coexpression of ^{S422D}SGK1, ^{T504A}EAAT4 activity is stimulated significantly while the activity of ^{T40A}EAAT4 remains unaltered. Western blotting confirmed proper SGK1 expression. Arithmetic means \pm SEM. * indicates statistically significant difference to uptake in *Xenopus* oocytes expressing wild-type EAAT4 alone. + indicates statistically significant difference to uptake in *Xenopus* oocytes expressing ^{T504A}EAAT4 alone. Uptake values were normalized to the mean value obtained in oocytes expressing wild-type EAAT4. n = 20.

6.2.4 Phosphorylation at Thr40 on EAAT4 is required for enhanced EAAT4 plasma membrane abundance

Further experiments were performed to pursue whether ablation of SGK1 phosphorylation sites in EAAT4 blunts the kinase effect on plasma membrane abundance. To investigate cell surface expression of wild type and EAAT4 mutants, fusion constructs containing a hemagglutinin (HA)-tag in an extracellular loop were generated by two-stage site-directed mutagenesis and expressed in *Xenopus* oocytes.

EAAT4 plasma membrane abundance examined by quantitative immunoassays revealed that the expression of the EAAT4 phosphorylation-deficient (^{T40A}EAAT4) mutant was unaffected by SGK1 (from 101.44 ± 11.29 % of control, n = 53, in ^{T40A}EAAT4 expressing oocytes to 104.72 ± 14.08 % of control, n = 42, in oocytes expressing ^{T40A}EAAT4 along with ^{S422D}SGK1, Figure 22). Phosphorylation at Thr40 appears to be responsible for the increased EAAT4 abundance since ^{T504A}EAAT4 expression was augmented upon expression of the kinase (from 100.00 ± 9.15 % of control, n = 36 to 186.98 ± 28.58 % of control, n = 36).

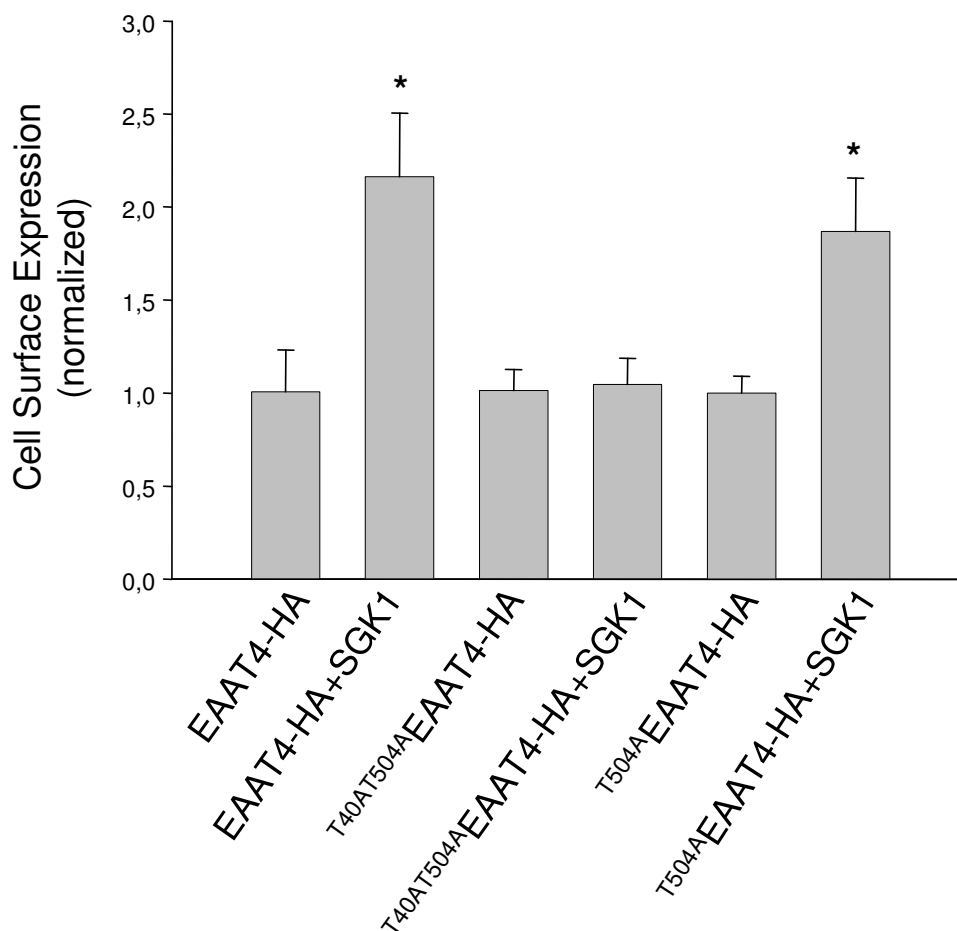

Figure 22 ^{S422D}SGK1 coexpressed with ^{T504A}EAAT4 enhances the plasma membrane abundance of the transporter noticeably. However, the kinase does not enhance the plasma membrane abundance when coexpressed with ^{T40A}^{T504A}EAAT4. Arithmetic means \pm SEM. * indicates statistically significant difference to oocytes injected with EAAT4 or ^{T504A}EAAT4 alone. Cell surface expression was normalized in each batch of oocytes to the mean RLU (Relative Light Units) value obtained in oocytes expressing EAAT4 alone. n= 36.

6.2.5 Nedd4-2 coexpression inhibits the activity of EAAT4

Prior to study the impact of silencing endogenous Nedd4-2 on the glutamate transporter activity, Nedd4-2 and EAAT4 were expressed in *Xenopus* oocytes and the effect of the ubiquitin ligase on EAAT4 was analyzed.

EAAT4 cRNA alone or along with Nedd4-2 cRNA was injected in oocytes and its activity was measured on the fifth day after injection using tracer flux

measurements. Figure 23 shows the downregulation of EAAT4 activity upon Nedd4-2 expression ($58.65 \pm 9.97\%$ of control, $n=20$).

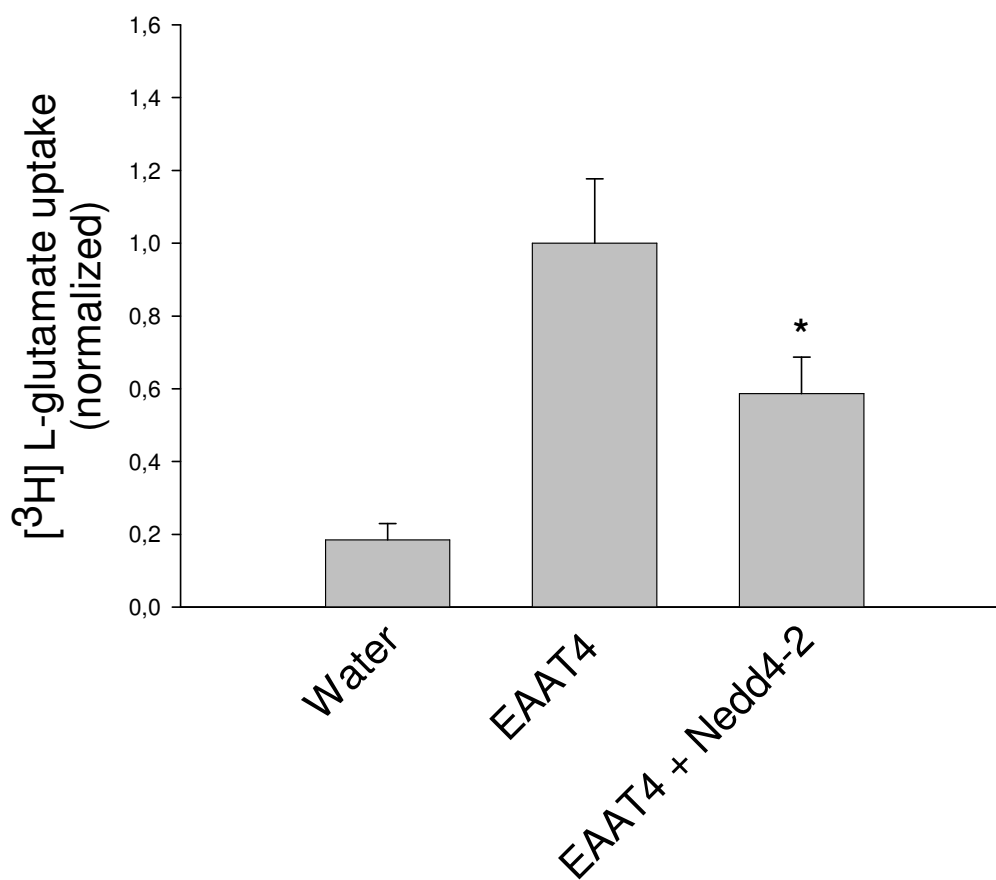

Figure 23 Expression of the ubiquitin ligase Nedd4-2 downregulates EAAT4 activity significantly. Arithmetic means \pm SEM. * indicates statistically significant difference to uptake in *Xenopus* oocytes expressing wild-type EAAT4 alone. Uptake values were normalized to the mean value obtained in oocytes expressing wild-type EAAT4 alone. $n=20$.

6.2.6 Silencing of intrinsic xNedd4-2 upregulates EAAT4 function

SGK1 modulates several transporters indirectly through phosphorylation and thus inhibition of the ubiquitin ligase Nedd4-2, which otherwise tags its target protein for degradation^{38,60,176}.

Since *Xenopus* oocytes possess intrinsic Nedd4-2 (xNedd4-2), SGK1 could additionally be effective through xNedd4-2 inhibition. Silencing experiments using

the RNAi sequence-specific posttranscriptional silencing technique in *Xenopus* oocytes were performed to assess whether xNedd4-2 downregulation promotes EAAT4 activity.

Oocytes were injected with EAAT4 alone or together with a double-stranded xNedd4-2 specific siRNA oligo. On the fifth day of cRNA injection, L-glutamate was measured. Functional studies showed enhanced EAAT4 activity in Nedd4-2 silenced oocytes (256.67 ± 53.38 % of control, $n = 14$, Figure 24).

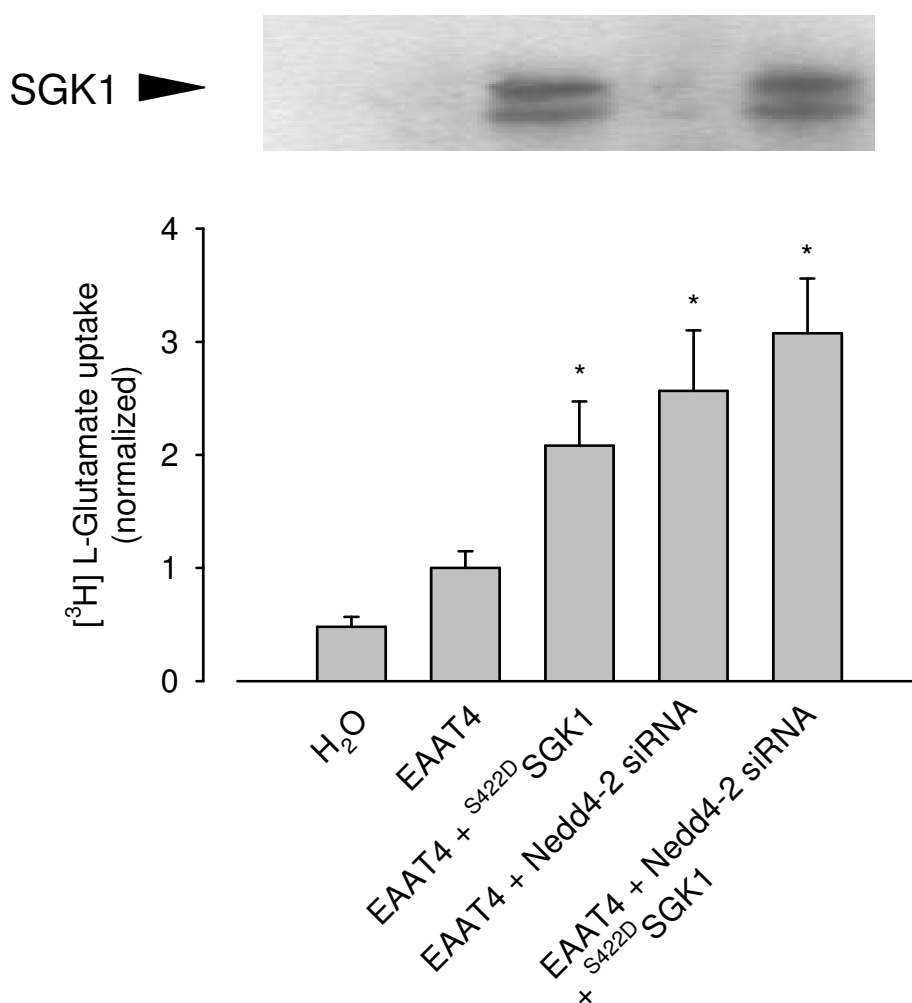

Figure 24 Significant enhancement of EAAT4 activity is noticed when intrinsic xNedd4-2 is silenced in oocytes. S^{422D}SGK1 expressed along with Nedd4-2 siRNA and EAAT4 further enhances the transporters' activity. Western blotting confirmed proper SGK1 expression. Arithmetic means \pm SEM. * indicates statistically significant difference to uptake in *Xenopus* oocytes expressing wild-type EAAT4 alone. Uptake values were normalized to the mean value obtained in oocytes expressing EAAT4. $n = 14$.

6.2.6.1 xNedd4-2 siRNA downregulates xNedd4-2 expression

To demonstrate xNedd4-2 silencing, xNedd4-2 protein levels were analysed by western blotting. Oocytes injected with EAAT4 alone and with xNedd4-2 siRNA were lysed separately on the fifth day of injection and were analysed for Nedd4-2 expression. Western blots confirmed the significant declination of intrinsic Nedd4-2 expression.

Densitometric analysis of Nedd4-2/GAPDH ratio of band intensities revealed a reduced (by two fold) Nedd4-2 expression in oocytes injected with xNedd4-2 siRNA oligo (Figure 25).

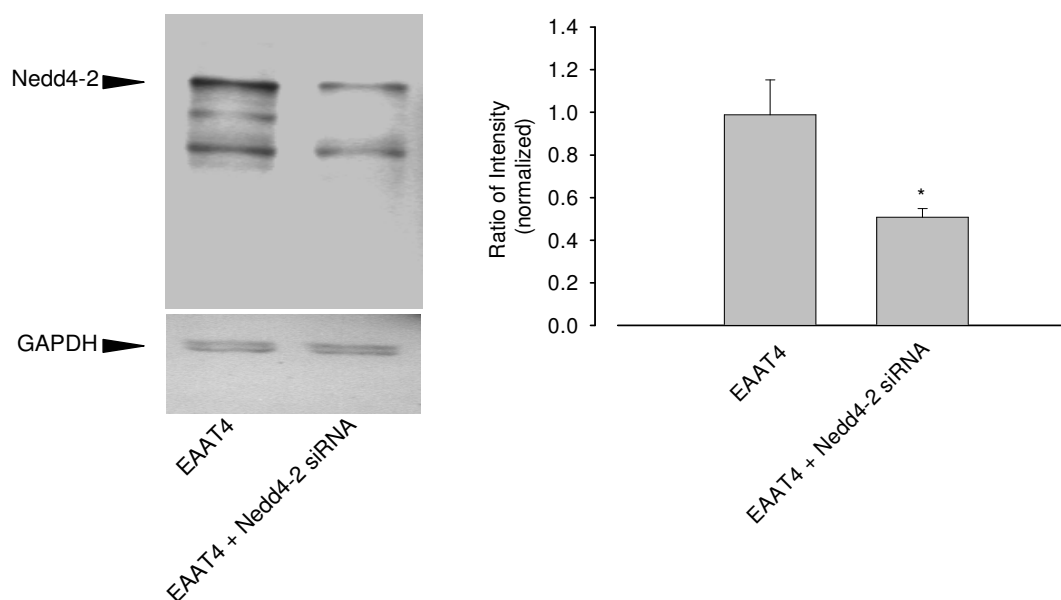

Figure 25 Western blot reveals the significant declination of intrinsic xNedd4-2 abundance upon injection of Nedd4-2 siRNA. Nedd4-2/GAPDH band intensities from three independent experiments were normalized in each batch to the value of Nedd4-2/GAPDH band intensity of oocytes expressing EAAT4 alone.

6.2.6.2 xNedd4-2 siRNA does not alter GLUT1 expression

To demonstrate the specificity of the effect observed, the activity of the facilitative glucose transporter GLUT1, that was previously reported to be unaffected by Nedd4-2, was studied upon injection of xNedd4-2 siRNA oligo.

GLUT1 function was not significantly altered by the coexpression of xNedd4-2 siRNA (75.21 ± 9.65 % of control, $n = 27$, Figure 26).

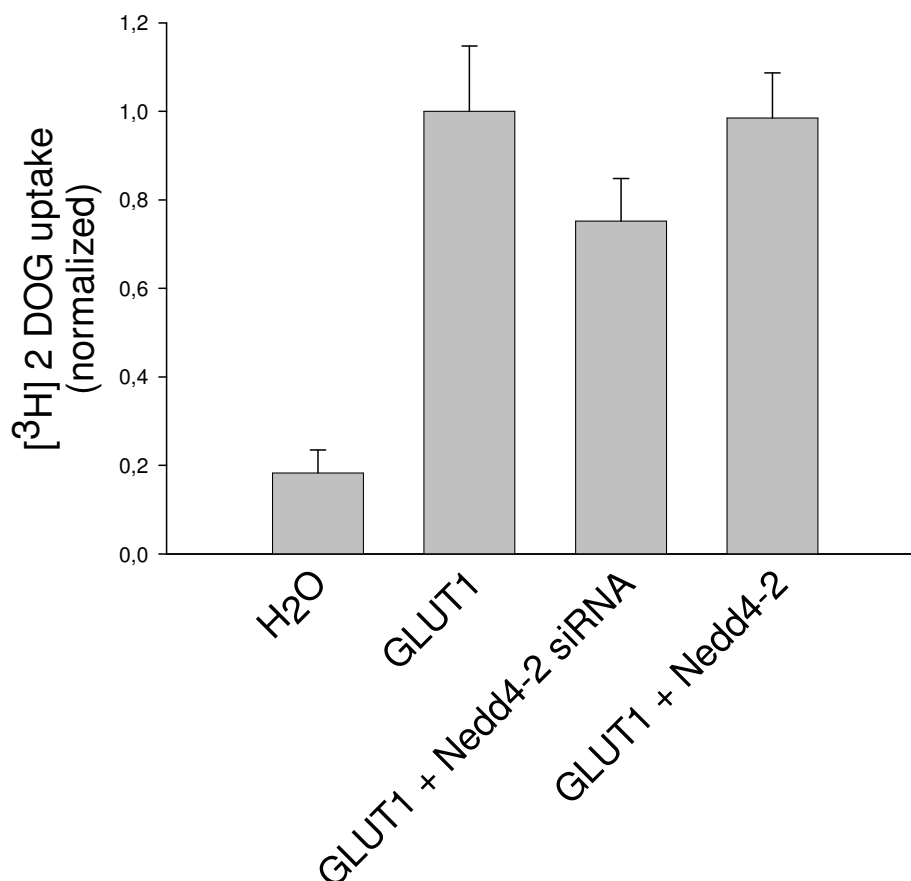

Figure 26 Injection of xNedd4-2 siRNA does not significantly alter GLUT1 expression, thus demonstrating Nedd4-2 siRNA specificity. Arithmetic means \pm SEM. Uptake values were normalized to the mean value obtained in oocytes expressing GLUT1 alone. $n = 27$.

7 Discussion

The present data reveals two novel modulators of the sodium dependent glutamate transporters EAAT2 and EAAT4 namely the protein kinase SGK1 and the ubiquitin ligase Nedd4-2. SGK1 upregulates EAAT2 and EAAT4, while Nedd4-2 downregulates both transporters. The EAAT2 transporter does not bear a SGK1 consensus motif. Thus, the kinase modulates the transporter through an intermediate protein. We and others have shown that SGK binds to and phosphorylates Nedd4-2 thus decreasing the affinity of the ubiquitin ligase to its target proteins^{60,177,178}. Therefore, SGK1 might be effective through phosphorylation of Nedd4-2, an assumption supported by the observation that the Nedd4-2 mutant mimicking the SGK1-phosphorylated form does not impact EAAT2 function. However, the effect of Nedd4-2 is not completely abolished by SGK1, which may indicate that SGK1 cannot completely suppress Nedd4-2 function. On the other hand, SGK1 may not exclusively be effective through phosphorylation of Nedd4-2 and additional intermediary proteins are yet to be identified.

SGK1 enhances the carrier protein abundance. In a previous study utilizing brefeldin A, a drug interfering with the exocytotic pathway, we were able to demonstrate that SGK1 delays the clearance of transport proteins from the cell membrane³¹. However, in the case of EAAT2, it is not known whether delayed clearance of the transporter from the membrane causes its increased cell surface abundance. Further studies are required to clarify this issue.

Nedd4-2 and SGK1 may participate in the signaling of neuroexcitability and neuroexcitotoxicity. According to the present results, Nedd4-2 would downregulate EAAT2 and thus delay the clearance of glutamate from the extracellular space. As a result the effects of glutamate may be enhanced. SGK1, on the other hand, is expected to accelerate the clearance of glutamate from the extracellular space and thus foster termination of an excitatory signal.

Enhanced expression of EAAT2 has been shown to protect against excitotoxic neuronal death^{179,180} and deranged function of EAAT2 has been implicated in several neuronal diseases including amyotrophic lateral sclerosis^{169,181,182}, epilepsy¹⁸³⁻¹⁸⁵ and

Alzheimer disease^{186,187}. Moreover, lack of EAAT2 function was shown to potentiate retinal ganglion cell death¹⁸⁸. In axotomy or after spinal cord injury, EAAT2 has been shown to be upregulated, an effect thought to play a protective role^{189,190} and overexpression of EAAT2 appears to protect against motor neuron degeneration and epilepsy. During ischemia, on the other hand, a reversed mode function of EAAT1 and of EAAT2 has been postulated to enhance extracellular glutamate concentration¹⁹¹. Inappropriate regulation of the carriers by Nedd4-2 and/or SGK1 could similarly participate in the pathophysiology of those diseases.

The ability of SGK1 to stimulate EAAT2 activity is also observed with the isoforms SGK2 and SGK3 and with protein kinase B. Thus, these kinases have the potential to replace SGK1 in this functional capacity. This may be one reason for the apparently mild phenotype of the SGK1-knockout mouse¹⁹². Complete knockout of PDK1, i.e. the kinase upstream of all three SGKs and PKB, is not compatible with survival¹⁹³.

Taken together, the present study provides evidence that the serum and glucocorticoid inducible kinase isoforms SGK1, SGK2 and SGK3 and the related kinase PKB can regulate the glutamate transporter EAAT2. The kinases phosphorylate the ubiquitin ligase Nedd4-2 and thereby stimulate the activity and cell surface expression of EAAT2. The mechanism is likely to participate in the regulation of neuronal excitability.

EAAT4 bears two putative SGK1 consensus sites (Thr40 and Thr504) that are highly conserved among several species suggesting that these sites might play a role in the transporter's function. Our data provide evidence that the kinase modulates EAAT4 activity directly and that, from both putative SGK1 phosphorylation sites, the residue Thr40 is essential for SGK1 induced stimulation of EAAT4 function and surface abundance.

SGK1 is also capable to enhance the activity of other members of the excitatory amino acid transporter family (EAAT1, EAAT3 and EAAT5)^{38,39,41,194}. Similar to EAAT4, the glial transporter EAAT1 is upregulated by SGK1 in part via direct phosphorylation at a putative SGK1 consensus site (Thr482)³⁸. EAAT1

function was enhanced by SGK1 in the presence of ^{S382A, S468A} Nedd4-2, while EAAT1 expressed alone with ^{S382A, S468A} Nedd4-2 showed a decrease in current.

The transporters EAAT3 and EAAT5 do not contain any SGK1 phosphorylation site in its sequence and might therefore be regulated indirectly or directly at a non-SGK1 consensus site. In the present study we further show that EAAT2 expression and activity is upregulated by SGK1 through phosphorylation and thus inhibition of the ubiquitin ligase Nedd4-2¹⁹⁴. This mechanism of SGK1 action is shared by EAAT1 and EAAT4, according to our present results on xNedd4-2 silencing in which EAAT4 activity was augmented in oocytes injected with xNedd4-2-specific siRNA oligos.

The mechanisms by which SGK1 promotes EAAT3 and EAAT5 activity are still undefined. They might include the phosphorylation of a hitherto unknown intermediate protein since coexpression of a catalytically inactive SGK1 mutant failed to modulate the transporters⁴¹.

Phosphorylation processes are known to modulate EAATs activity. Several growth factors that are neuroprotective enhance EAAT activities via activation of kinases: insulin-like growth factor-1 (IGF-1), epidermal growth factor receptor (EGFR) agonists and platelet-derived growth factor (PDGF) upregulate EAAT1, EAAT2 and EAAT3 respectively via phosphatidylinositol 3 kinase (PI3K) as demonstrated by PI3K inhibitors and constitutively active PI3K constructs¹⁹⁵⁻¹⁹⁷. Since SGK1 is activated by PI3K, the kinase might be the downstream effector in the PI3K signalling pathway activated by those growth factors.

Besides, SGK1 itself is stimulated at gene transcriptional level by agonists such as mineralocorticoids⁴⁻⁶, follicle stimulating hormone (FSH)^{7,8}, transforming growth factor β (TGF- β)^{9,10}, and thrombin¹¹. Stimulation of SGK1 may lead to the enhancement of other ion channels and transporters where SGK1 is localized. For instance, cerebellar SGK1 expression was enhanced in the cerebellar Purkinje cells of mice grown under dehydration condition, where EAAT4 predominantly express⁴⁰. Accordingly SGK1 has the possibility to stimulate the EAAT4 activity in Purkinje cells under such stress conditions.

EAATs contain at least two putative phosphorylation sites for PKC and one for PKA¹⁹⁸. Several reports have shown PKC and PKA modulation of glutamate transporters^{170,199-202}. Activation of PKC enhances GLT1 (EAAT2) in HeLa transfected cells and EAAC1 (EAAT3) in C6 Glioma cells^{170,199}, whereas decreases GLAST activity in Bergmann glial cells^{147,148}.

Similar to SGK1, PKC modulates EAATs through different mechanisms: directly as a result of transporter phosphorylation at a putative PKC phosphorylation site (i.e. Ser113 on GLT1 sequence)¹⁷⁰ or indirectly through phosphorylation of intermediate proteins¹⁴⁷. In contrast to SGK1, PKC modulates several EAATs by enhancing the transporter catalytic activity without altering its surface abundance¹⁷⁰.

In contrary to SGK1, Nedd4-2 was known to downregulate all members of the excitatory amino acid transporter family except for EAAT5^{41,203}. SGK1 expressed along with Nedd4-2 and the EAATs (EAAT1-4) inhibited the downregulating property of Nedd4-2 and additionally enhanced EAAT1-4 activity^{38-41,194,203}.

In summary, the results presented here indicate that SGK1 modulates EAAT4 function and plasma membrane abundance via direct phosphorylation of the transporter. The residue Thr40 within the SGK1 consensus site present in EAAT4 is essential for the SGK1 stimulatory effects. SGK1 might additionally be effective through phosphorylation and thus inhibition of intrinsic ubiquitin ligase Nedd4-2 as suggested by our silencing experiments. Understanding the signalling mechanisms regulating EAAT4 may have significant implications for developing novel drugs to limit neuroexcitotoxicity.

8 References

1. Lang,F. & Cohen,P. Regulation and physiological roles of serum- and glucocorticoid-induced protein kinase isoforms. *Sci. STKE*. **2001**, RE17 (2001).
2. Webster,M.K., Goya,L. & Firestone,G.L. Immediate-early transcriptional regulation and rapid mRNA turnover of a putative serine/threonine protein kinase. *J. Biol. Chem.* **268**, 11482-11485 (1993).
3. Webster,M.K., Goya,L., Ge,Y., Maiyar,A.C. & Firestone,G.L. Characterization of sgk, a novel member of the serine/threonine protein kinase gene family which is transcriptionally induced by glucocorticoids and serum. *Mol. Cell Biol.* **13**, 2031-2040 (1993).
4. Brennan,F.E. & Fuller,P.J. Rapid upregulation of serum and glucocorticoid-regulated kinase (sgk) gene expression by corticosteroids in vivo. *Mol. Cell Endocrinol.* **166**, 129-136 (2000).
5. Chen,S.Y. *et al.* Epithelial sodium channel regulated by aldosterone-induced protein sgk. *Proc. Natl. Acad. Sci. U. S. A* **96**, 2514-2519 (1999).
6. Shigaev,A., Asher,C., Latter,H., Garty,H. & Reuveny,E. Regulation of sgk by aldosterone and its effects on the epithelial Na(+) channel. *Am. J. Physiol Renal Physiol* **278**, F613-F619 (2000).
7. Alliston,T.N., Maiyar,A.C., Buse,P., Firestone,G.L. & Richards,J.S. Follicle stimulating hormone-regulated expression of serum/glucocorticoid-inducible kinase in rat ovarian granulosa cells: a functional role for the Sp1 family in promoter activity. *Mol. Endocrinol.* **11**, 1934-1949 (1997).
8. Gonzalez-Robayna,I.J., Falender,A.E., Ochsner,S., Firestone,G.L. & Richards,J.S. Follicle-Stimulating hormone (FSH) stimulates phosphorylation and activation of protein kinase B (PKB/Akt) and serum and glucocorticoid-Induced kinase (Sgk): evidence for A kinase-independent signaling by FSH in granulosa cells. *Mol. Endocrinol.* **14**, 1283-1300 (2000).

9. Lang,F. *et al.* Deranged transcriptional regulation of cell-volume-sensitive kinase hSGK in diabetic nephropathy. *Proc. Natl. Acad. Sci. U. S. A* **97**, 8157-8162 (2000).
10. Waldegger,S. *et al.* h-sgk serine-threonine protein kinase gene as transcriptional target of transforming growth factor beta in human intestine. *Gastroenterology* **116**, 1081-1088 (1999).
11. Kumar,J.M., Brooks,D.P., Olson,B.A. & Laping,N.J. Sgk, a putative serine/threonine kinase, is differentially expressed in the kidney of diabetic mice and humans. *J. Am. Soc. Nephrol.* **10**, 2488-2494 (1999).
12. Bell,L.M. *et al.* Hyperosmotic stress stimulates promoter activity and regulates cellular utilization of the serum- and glucocorticoid-inducible protein kinase (Sgk) by a p38 MAPK-dependent pathway. *J. Biol. Chem.* **275**, 25262-25272 (2000).
13. Waldegger,S., Barth,P., Raber,G. & Lang,F. Cloning and characterization of a putative human serine/threonine protein kinase transcriptionally modified during anisotonic and isotonic alterations of cell volume. *Proc. Natl. Acad. Sci. U. S. A* **94**, 4440-4445 (1997).
14. Kobayashi,T., Deak,M., Morrice,N. & Cohen,P. Characterization of the structure and regulation of two novel isoforms of serum- and glucocorticoid-induced protein kinase. *Biochem. J.* **344 Pt 1**, 189-197 (1999).
15. Hollister,R.D., Page,K.J. & Hyman,B.T. Distribution of the messenger RNA for the extracellularly regulated kinases 1, 2 and 3 in rat brain: effects of excitotoxic hippocampal lesions. *Neuroscience* **79**, 1111-1119 (1997).
16. Imaizumi,K., Tsuda,M., Wanaka,A., Tohyama,M. & Takagi,T. Differential expression of sgk mRNA, a member of the Ser/Thr protein kinase gene family, in rat brain after CNS injury. *Brain Res. Mol. Brain Res.* **26**, 189-196 (1994).
17. Waldegger,S. *et al.* Genomic organization and chromosomal localization of the human SGK protein kinase gene. *Genomics* **51**, 299-302 (1998).

18. Dai,F. *et al.* Cloning and mapping of a novel human serum/glucocorticoid regulated kinase-like gene, SGKL, to chromosome 8q12.3-q13.1. *Genomics* **62**, 95-97 (1999).
19. Klingel,K. *et al.* Expression of cell volume-regulated kinase h-sgk in pancreatic tissue. *Am. J. Physiol Gastrointest. Liver Physiol* **279**, G998-G1002 (2000).
20. Kobayashi,T. & Cohen,P. Activation of serum- and glucocorticoid-regulated protein kinase by agonists that activate phosphatidylinositide 3-kinase is mediated by 3-phosphoinositide-dependent protein kinase-1 (PDK1) and PDK2. *Biochem. J.* **339 (Pt 2)**, 319-328 (1999).
21. Liu,D., Yang,X. & Songyang,Z. Identification of CISK, a new member of the SGK kinase family that promotes IL-3-dependent survival. *Curr. Biol.* **10**, 1233-1236 (2000).
22. Alliston,T.N., Gonzalez-Robayna,I.J., Buse,P., Firestone,G.L. & Richards,J.S. Expression and localization of serum/glucocorticoid-induced kinase in the rat ovary: relation to follicular growth and differentiation. *Endocrinology* **141**, 385-395 (2000).
23. Gonzalez-Robayna,I.J., Alliston,T.N., Buse,P., Firestone,G.L. & Richards,J.S. Functional and subcellular changes in the A-kinase-signaling pathway: relation to aromatase and Sgk expression during the transition of granulosa cells to luteal cells. *Mol. Endocrinol.* **13**, 1318-1337 (1999).
24. Buse,P. *et al.* Cell cycle and hormonal control of nuclear-cytoplasmic localization of the serum- and glucocorticoid-inducible protein kinase, Sgk, in mammary tumor cells. A novel convergence point of anti-proliferative and proliferative cell signaling pathways. *J. Biol. Chem.* **274**, 7253-7263 (1999).
25. Park,J. *et al.* Serum and glucocorticoid-inducible kinase (SGK) is a target of the PI 3-kinase-stimulated signaling pathway. *EMBO J.* **18**, 3024-3033 (1999).
26. Bohmer,C. *et al.* The shrinkage-activated Na(+) conductance of rat hepatocytes and its possible correlation to rENaC. *Cell Physiol Biochem.* **10**, 187-194 (2000).

27. Lang,F. *et al.* Functional significance of cell volume regulatory mechanisms. *Physiol Rev.* **78**, 247-306 (1998).
28. Lang,F., Busch,G.L. & Volkl,H. The diversity of volume regulatory mechanisms. *Cell Physiol Biochem.* **8**, 1-45 (1998).
29. Hoffman,B.B., Sharma,K., Zhu,Y. & Ziyadeh,F.N. Transcriptional activation of transforming growth factor-beta1 in mesangial cell culture by high glucose concentration. *Kidney Int.* **54**, 1107-1116 (1998).
30. Boehmer,C. *et al.* Serum and glucocorticoid inducible kinases in the regulation of the cardiac sodium channel SCN5A. *Cardiovasc. Res.* **57**, 1079-1084 (2003).
31. Yun,C.C. *et al.* The serum and glucocorticoid-inducible kinase SGK1 and the Na⁺/H⁺ exchange regulating factor NHERF2 synergize to stimulate the renal outer medullary K⁺ channel ROMK1. *J. Am. Soc. Nephrol.* **13**, 2823-2830 (2002).
32. Embark,H.M., Bohmer,C., Vallon,V., Luft,F. & Lang,F. Regulation of KCNE1-dependent K(+) current by the serum and glucocorticoid-inducible kinase (SGK) isoforms. *Pflugers Arch.* **445**, 601-606 (2003).
33. Gamper,N. *et al.* IGF-1 up-regulates K⁺ channels via PI3-kinase, PDK1 and SGK1. *Pflugers Arch.* **443**, 625-634 (2002).
34. Gamper,N. *et al.* K⁺ channel activation by all three isoforms of serum- and glucocorticoid-dependent protein kinase SGK. *Pflugers Arch.* **445**, 60-66 (2002).
35. Warntges,S. *et al.* Cerebral localization and regulation of the cell volume-sensitive serum- and glucocorticoid-dependent kinase SGK1. *Pflugers Arch.* **443**, 617-624 (2002).
36. Yun,C.C., Chen,Y. & Lang,F. Glucocorticoid activation of Na(+)/H(+) exchanger isoform 3 revisited. The roles of SGK1 and NHERF2. *J. Biol. Chem.* **277**, 7676-7683 (2002).

37. Boehmer,C. *et al.* Stimulation of renal Na⁺ dicarboxylate cotransporter 1 by Na⁺/H⁺ exchanger regulating factor 2, serum and glucocorticoid inducible kinase isoforms, and protein kinase B. *Biochem. Biophys. Res. Commun.* **313**, 998-1003 (2004).
38. Boehmer,C. *et al.* Regulation of the glutamate transporter EAAT1 by the ubiquitin ligase Nedd4-2 and the serum and glucocorticoid-inducible kinase isoforms SGK1/3 and protein kinase B. *J. Neurochem.* **86**, 1181-1188 (2003).
39. Schniepp,R. *et al.* Retinal colocalization and in vitro interaction of the glutamate transporter EAAT3 and the serum- and glucocorticoid-inducible kinase SGK1 [correction]. *Invest Ophthalmol. Vis. Sci.* **45**, 1442-1449 (2004).
40. Bohmer,C. *et al.* Stimulation of the EAAT4 glutamate transporter by SGK protein kinase isoforms and PKB. *Biochem. Biophys. Res. Commun.* **324**, 1242-1248 (2004).
41. Boehmer,C. *et al.* Regulation of the excitatory amino acid transporter EAAT5 by the serum and glucocorticoid dependent kinases SGK1 and SGK3. *Biochem. Biophys. Res. Commun.* **329**, 738-742 (2005).
42. Henke,G., Setiawan,I., Bohmer,C. & Lang,F. Activation of Na⁺/K⁺-ATPase by the serum and glucocorticoid-dependent kinase isoforms. *Kidney Blood Press Res.* **25**, 370-374 (2002).
43. Lang,F. *et al.* (Patho)physiological significance of the serum- and glucocorticoid-inducible kinase isoforms. *Physiol Rev.* **86**, 1151-1178 (2006).
44. Flores,S.Y., Debonneville,C. & Staub,O. The role of Nedd4/Nedd4-like dependant ubiquitylation in epithelial transport processes. *Pflugers Arch.* **446**, 334-338 (2003).
45. Hougaard,C., Klaerke,D.A., Hoffmann,E.K., Olesen,S.P. & Jorgensen,N.K. Modulation of KCNQ4 channel activity by changes in cell volume. *Biochim. Biophys. Acta* **1660**, 1-6 (2004).
46. Kubisch,C. *et al.* KCNQ4, a novel potassium channel expressed in sensory outer hair cells, is mutated in dominant deafness. *Cell* **96**, 437-446 (1999).

47. Aronzon,A., Ruckenstein,M.J. & Bigelow,D.C. The efficacy of corticosteroids in restoring hearing in patients undergoing conservative management of acoustic neuromas. *Otol. Neurotol.* **24**, 465-468 (2003).
48. Hillman,T.M., Arriaga,M.A. & Chen,D.A. Intratympanic steroids: do they acutely improve hearing in cases of cochlear hydrops? *Laryngoscope* **113**, 1903-1907 (2003).
49. Iwasaki,Y., Ikeda,K. & Kinoshita,M. Plasma amino acid levels in patients with amyotrophic lateral sclerosis. *J. Neurol. Sci.* **107**, 219-222 (1992).
50. Pioro,E.P., Majors,A.W., Mitsumoto,H., Nelson,D.R. & Ng,T.C. ¹H-MRS evidence of neurodegeneration and excess glutamate + glutamine in ALS medulla. *Neurology* **53**, 71-79 (1999).
51. Plaitakis,A. & Caroscio,J.T. Abnormal glutamate metabolism in amyotrophic lateral sclerosis. *Ann. Neurol.* **22**, 575-579 (1987).
52. Rothstein,J.D. *et al.* Abnormal excitatory amino acid metabolism in amyotrophic lateral sclerosis. *Ann. Neurol.* **28**, 18-25 (1990).
53. Martin,L.J. *et al.* Hypoxia-ischemia causes abnormalities in glutamate transporters and death of astroglia and neurons in newborn striatum. *Ann. Neurol.* **42**, 335-348 (1997).
54. Otori,Y. *et al.* Marked increase in glutamate-aspartate transporter (GLAST/GluT-1) mRNA following transient retinal ischemia. *Brain Res. Mol. Brain Res.* **27**, 310-314 (1994).
55. Szatkowski,M. & Attwell,D. Triggering and execution of neuronal death in brain ischaemia: two phases of glutamate release by different mechanisms. *Trends Neurosci.* **17**, 359-365 (1994).
56. Parekh,A.B. & Penner,R. Store depletion and calcium influx. *Physiol Rev.* **77**, 901-930 (1997).
57. Berridge,M.J., Lipp,P. & Bootman,M.D. The versatility and universality of calcium signalling. *Nat. Rev. Mol. Cell Biol.* **1**, 11-21 (2000).

58. Brunet,A. *et al.* Protein kinase SGK mediates survival signals by phosphorylating the forkhead transcription factor FKHL1 (FOXO3a). *Mol. Cell Biol.* **21**, 952-965 (2001).
59. Zhang,L., Cui,R., Cheng,X. & Du,J. Antiapoptotic effect of serum and glucocorticoid-inducible protein kinase is mediated by novel mechanism activating I{kappa}B kinase. *Cancer Res.* **65**, 457-464 (2005).
60. Debonneville,C. *et al.* Phosphorylation of Nedd4-2 by Sgk1 regulates epithelial Na(+) channel cell surface expression. *EMBO J.* **20**, 7052-7059 (2001).
61. Friedrich,B. *et al.* The serine/threonine kinases SGK2 and SGK3 are potent stimulators of the epithelial Na⁺ channel alpha,beta,gamma-ENaC. *Pflugers Arch.* **445**, 693-696 (2003).
62. Bellacosa,A., Testa,J.R., Staal,S.P. & Tsichlis,P.N. A retroviral oncogene, akt, encoding a serine-threonine kinase containing an SH2-like region. *Science* **254**, 274-277 (1991).
63. Staal,S.P., Hartley,J.W. & Rowe,W.P. Isolation of transforming murine leukemia viruses from mice with a high incidence of spontaneous lymphoma. *Proc. Natl. Acad. Sci. U. S. A* **74**, 3065-3067 (1977).
64. Coffey,P.J. & Woodgett,J.R. Molecular cloning and characterisation of a novel putative protein-serine kinase related to the cAMP-dependent and protein kinase C families. *Eur. J. Biochem.* **201**, 475-481 (1991).
65. Jones,P.F., Jakubowicz,T., Pitossi,F.J., Maurer,F. & Hemmings,B.A. Molecular cloning and identification of a serine/threonine protein kinase of the second-messenger subfamily. *Proc. Natl. Acad. Sci. U. S. A* **88**, 4171-4175 (1991).
66. Altomare,D.A. *et al.* Cloning, chromosomal localization and expression analysis of the mouse Akt2 oncogene. *Oncogene* **11**, 1055-1060 (1995).
67. Brodbeck,D., Cron,P. & Hemmings,B.A. A human protein kinase Bgamma with regulatory phosphorylation sites in the activation loop and in the C-terminal hydrophobic domain. *J. Biol. Chem.* **274**, 9133-9136 (1999).

68. Jones,P.F., Jakubowicz,T. & Hemmings,B.A. Molecular cloning of a second form of rac protein kinase. *Cell Regul.* **2**, 1001-1009 (1991).
69. Nakatani,K., Sakaue,H., Thompson,D.A., Weigel,R.J. & Roth,R.A. Identification of a human Akt3 (protein kinase B gamma) which contains the regulatory serine phosphorylation site. *Biochem. Biophys. Res. Commun.* **257**, 906-910 (1999).
70. Altomare,D.A., Lyons,G.E., Mitsuuchi,Y., Cheng,J.Q. & Testa,J.R. Akt2 mRNA is highly expressed in embryonic brown fat and the AKT2 kinase is activated by insulin. *Oncogene* **16**, 2407-2411 (1998).
71. Konishi,H. *et al.* Activation of RAC-protein kinase by heat shock and hyperosmolarity stress through a pathway independent of phosphatidylinositol 3-kinase. *Proc. Natl. Acad. Sci. U. S. A* **93**, 7639-7643 (1996).
72. Cross,D.A., Alessi,D.R., Cohen,P., Andjelkovich,M. & Hemmings,B.A. Inhibition of glycogen synthase kinase-3 by insulin mediated by protein kinase B. *Nature* **378**, 785-789 (1995).
73. Franke,T.F. *et al.* The protein kinase encoded by the Akt proto-oncogene is a target of the PDGF-activated phosphatidylinositol 3-kinase. *Cell* **81**, 727-736 (1995).
74. Burgering,B.M. & Coffey,P.J. Protein kinase B (c-Akt) in phosphatidylinositol-3-OH kinase signal transduction. *Nature* **376**, 599-602 (1995).
75. Kandel,E.S. & Hay,N. The regulation and activities of the multifunctional serine/threonine kinase Akt/PKB. *Exp. Cell Res.* **253**, 210-229 (1999).
76. Liu,A.X. *et al.* AKT2, a member of the protein kinase B family, is activated by growth factors, v-Ha-ras, and v-src through phosphatidylinositol 3-kinase in human ovarian epithelial cancer cells. *Cancer Res.* **58**, 2973-2977 (1998).
77. Dudek,H. *et al.* Regulation of neuronal survival by the serine-threonine protein kinase Akt. *Science* **275**, 661-665 (1997).
78. Kauffmann-Zeh,A. *et al.* Suppression of c-Myc-induced apoptosis by Ras signalling through PI(3)K and PKB. *Nature* **385**, 544-548 (1997).

79. Kennedy,S.G. *et al.* The PI 3-kinase/Akt signaling pathway delivers an anti-apoptotic signal. *Genes Dev.* **11**, 701-713 (1997).
80. Kulik,G., Klippel,A. & Weber,M.J. Antiapoptotic signalling by the insulin-like growth factor I receptor, phosphatidylinositol 3-kinase, and Akt. *Mol. Cell Biol.* **17**, 1595-1606 (1997).
81. Ciechanover,A. The ubiquitin-proteasome proteolytic pathway. *Cell* **79**, 13-21 (1994).
82. Ciechanover,A. The ubiquitin-mediated proteolytic pathway: mechanisms of action and cellular physiology. *Biol. Chem. Hoppe Seyler* **375**, 565-581 (1994).
83. Hershko,A. & Ciechanover,A. The ubiquitin system for protein degradation. *Annu. Rev. Biochem.* **61**, 761-807 (1992).
84. Jentsch,S. The ubiquitin-conjugation system. *Annu. Rev. Genet.* **26**, 179-207 (1992).
85. Anan,T. *et al.* Human ubiquitin-protein ligase Nedd4: expression, subcellular localization and selective interaction with ubiquitin-conjugating enzymes. *Genes Cells* **3**, 751-763 (1998).
86. Huibregtse,J.M., Scheffner,M. & Howley,P.M. Cloning and expression of the cDNA for E6-AP, a protein that mediates the interaction of the human papillomavirus E6 oncoprotein with p53. *Mol. Cell Biol.* **13**, 775-784 (1993).
87. Scheffner,M., Huibregtse,J.M., Vierstra,R.D. & Howley,P.M. The HPV-16 E6 and E6-AP complex functions as a ubiquitin-protein ligase in the ubiquitination of p53. *Cell* **75**, 495-505 (1993).
88. Huibregtse,J.M., Scheffner,M., Beaudenon,S. & Howley,P.M. A family of proteins structurally and functionally related to the E6-AP ubiquitin-protein ligase. *Proc. Natl. Acad. Sci. U. S. A* **92**, 2563-2567 (1995).
89. Nagase,T. *et al.* Prediction of the coding sequences of unidentified human genes. III. The coding sequences of 40 new genes (KIAA0081-KIAA0120) deduced by analysis of cDNA clones from human cell line KG-1. *DNA Res.* **2**, 37-43 (1995).

90. Abriel,H. *et al.* Defective regulation of the epithelial Na⁺ channel by Nedd4 in Liddle's syndrome. *J. Clin. Invest* **103**, 667-673 (1999).
91. Farr,T.J., Coddington-Lawson,S.J., Snyder,P.M. & McDonald,F.J. Human Nedd4 interacts with the human epithelial Na⁺ channel: WW3 but not WW1 binds to Na⁺-channel subunits. *Biochem. J.* **345 Pt 3**, 503-509 (2000).
92. Goulet,C.C. *et al.* Inhibition of the epithelial Na⁺ channel by interaction of Nedd4 with a PY motif deleted in Liddle's syndrome. *J. Biol. Chem.* **273**, 30012-30017 (1998).
93. Staub,O. *et al.* Regulation of the epithelial Na⁺ channel by Nedd4 and ubiquitination. *Kidney Int.* **57**, 809-815 (2000).
94. Kumar,S., Tomooka,Y. & Noda,M. Identification of a set of genes with developmentally down-regulated expression in the mouse brain. *Biochem. Biophys. Res. Commun.* **185**, 1155-1161 (1992).
95. Bens,M. *et al.* Corticosteroid-dependent sodium transport in a novel immortalized mouse collecting duct principal cell line. *J. Am. Soc. Nephrol.* **10**, 923-934 (1999).
96. Kamynina,E., Debonneville,C., Bens,M., Vandewalle,A. & Staub,O. A novel mouse Nedd4 protein suppresses the activity of the epithelial Na⁺ channel. *FASEB J.* **15**, 204-214 (2001).
97. Kamynina,E., Debonneville,C., Hirt,R.P. & Staub,O. Liddle's syndrome: a novel mouse Nedd4 isoform regulates the activity of the epithelial Na(+) channel. *Kidney Int.* **60**, 466-471 (2001).
98. Kamynina,E. & Staub,O. Concerted action of ENaC, Nedd4-2, and Sgk1 in transepithelial Na(+) transport. *Am. J. Physiol Renal Physiol* **283**, F377-F387 (2002).
99. Sudol,M. Structure and function of the WW domain. *Prog. Biophys. Mol. Biol.* **65**, 113-132 (1996).

100. Chan,D.C., Bedford,M.T. & Leder,P. Formin binding proteins bear WWP/WW domains that bind proline-rich peptides and functionally resemble SH3 domains. *EMBO J.* **15**, 1045-1054 (1996).
101. Scheffner,M., Nuber,U. & Huibregtse,J.M. Protein ubiquitination involving an E1-E2-E3 enzyme ubiquitin thioester cascade. *Nature* **373**, 81-83 (1995).
102. Kamynina,E., Tauxe,C. & Staub,O. Distinct characteristics of two human Nedd4 proteins with respect to epithelial Na(+) channel regulation. *Am. J. Physiol Renal Physiol* **281**, F469-F477 (2001).
103. Collingridge,G.L. & Lester,R.A. Excitatory amino acid receptors in the vertebrate central nervous system. *Pharmacol. Rev.* **41**, 143-210 (1989).
104. Fonnum,F. Glutamate: a neurotransmitter in mammalian brain. *J. Neurochem.* **42**, 1-11 (1984).
105. Headley,P.M. & Grillner,S. Excitatory amino acids and synaptic transmission: the evidence for a physiological function. *Trends Pharmacol. Sci.* **11**, 205-211 (1990).
106. Amara,S.G. & Fontana,A.C. Excitatory amino acid transporters: keeping up with glutamate. *Neurochem. Int.* **41**, 313-318 (2002).
107. Danbolt,N.C. Glutamate uptake. *Prog. Neurobiol.* **65**, 1-105 (2001).
108. Seal,R.P. & Amara,S.G. Excitatory amino acid transporters: a family in flux. *Annu. Rev. Pharmacol. Toxicol.* **39**, 431-456 (1999).
109. Augustine,G.J., Burns,M.E., DeBello,W.M., Pettit,D.L. & Schweizer,F.E. Exocytosis: proteins and perturbations. *Annu. Rev. Pharmacol. Toxicol.* **36**, 659-701 (1996).
110. Cousin,M.A. & Robinson,P.J. Mechanisms of synaptic vesicle recycling illuminated by fluorescent dyes. *J. Neurochem.* **73**, 2227-2239 (1999).
111. Johannes,L. & Galli,T. Exocytosis: SNAREs drum up! *Eur. J. Neurosci.* **10**, 415-422 (1998).

112. Sudhof,T.C. The synaptic vesicle cycle: a cascade of protein-protein interactions. *Nature* **375**, 645-653 (1995).
113. Schousboe,A. Transport and metabolism of glutamate and GABA in neurons are glial cells. *Int. Rev. Neurobiol.* **22**, 1-45 (1981).
114. During,M.J. & Spencer,D.D. Extracellular hippocampal glutamate and spontaneous seizure in the conscious human brain. *Lancet* **341**, 1607-1610 (1993).
115. Ferrie,C.D. *et al.* Plasma amino acids in childhood epileptic encephalopathies. *Epilepsy Res.* **34**, 221-229 (1999).
116. Janjua,N.A. *et al.* Familial increase in plasma glutamic acid in epilepsy. *Epilepsy Res.* **11**, 37-44 (1992).
117. Danbolt,N.C., Pines,G. & Kanner,B.I. Purification and reconstitution of the sodium- and potassium-coupled glutamate transport glycoprotein from rat brain. *Biochemistry* **29**, 6734-6740 (1990).
118. Pines,G. *et al.* Cloning and expression of a rat brain L-glutamate transporter. *Nature* **360**, 464-467 (1992).
119. Kanai,Y. & Hediger,M.A. Primary structure and functional characterization of a high-affinity glutamate transporter. *Nature* **360**, 467-471 (1992).
120. Storck,T., Schulte,S., Hofmann,K. & Stoffel,W. Structure, expression, and functional analysis of a Na(+)-dependent glutamate/aspartate transporter from rat brain. *Proc. Natl. Acad. Sci. U. S. A* **89**, 10955-10959 (1992).
121. Arriza,J.L. *et al.* Functional comparisons of three glutamate transporter subtypes cloned from human motor cortex. *J. Neurosci.* **14**, 5559-5569 (1994).
122. Arriza,J.L., Eliasof,S., Kavanaugh,M.P. & Amara,S.G. Excitatory amino acid transporter 5, a retinal glutamate transporter coupled to a chloride conductance. *Proc. Natl. Acad. Sci. U. S. A* **94**, 4155-4160 (1997).

123. Fairman,W.A., Vandenberg,R.J., Arriza,J.L., Kavanaugh,M.P. & Amara,S.G. An excitatory amino-acid transporter with properties of a ligand-gated chloride channel. *Nature* **375**, 599-603 (1995).
124. Kawakami,H., Tanaka,K., Nakayama,T., Inoue,K. & Nakamura,S. Cloning and expression of a human glutamate transporter. *Biochem. Biophys. Res. Commun.* **199**, 171-176 (1994).
125. Kanai,Y., Bhide,P.G., DiFiglia,M. & Hediger,M.A. Neuronal high-affinity glutamate transport in the rat central nervous system. *Neuroreport* **6**, 2357-2362 (1995).
126. Kirschner,M.A. *et al.* The mouse and human excitatory amino acid transporter gene (EAAT1) maps to mouse chromosome 15 and a region of syntenic homology on human chromosome 5. *Genomics* **22**, 631-633 (1994).
127. Kirschner,M.A., Copeland,N.G., Gilbert,D.J., Jenkins,N.A. & Amara,S.G. Mouse excitatory amino acid transporter EAAT2: isolation, characterization, and proximity to neuroexcitability loci on mouse chromosome 2. *Genomics* **24**, 218-224 (1994).
128. Maeno-Hikichi,Y. *et al.* Structure and functional expression of the cloned mouse neuronal high-affinity glutamate transporter. *Brain Res. Mol. Brain Res.* **48**, 176-180 (1997).
129. Mukainaka,Y., Tanaka,K., Hagiwara,T. & Wada,K. Molecular cloning of two glutamate transporter subtypes from mouse brain. *Biochim. Biophys. Acta* **1244**, 233-237 (1995).
130. Sutherland,M.L., Delaney,T.A. & Noebels,J.L. Molecular characterization of a high-affinity mouse glutamate transporter. *Gene* **162**, 271-274 (1995).
131. Tanaka,K. Cloning and expression of a glutamate transporter from mouse brain. *Neurosci. Lett.* **159**, 183-186 (1993).
132. Eliasof,S., Arriza,J.L., Leighton,B.H., Kavanaugh,M.P. & Amara,S.G. Excitatory amino acid transporters of the salamander retina: identification, localization, and function. *J. Neurosci.* **18**, 698-712 (1998).

133. Inoue,K., Sakaitani,M., Shimada,S. & Tohyama,M. Cloning and expression of a bovine glutamate transporter. *Brain Res. Mol. Brain Res.* **28**, 343-348 (1995).
134. Seal,R.P., Daniels,G.M., Wolfgang,W.J., Forte,M.A. & Amara,S.G. Identification and characterization of a cDNA encoding a neuronal glutamate transporter from *Drosophila melanogaster*. *Receptors. Channels* **6**, 51-64 (1998).
135. Tolner,B., Poolman,B. & Konings,W.N. Characterization and functional expression in *Escherichia coli* of the sodium/proton/glutamate symport proteins of *Bacillus stearothermophilus* and *Bacillus caldotenax*. *Mol. Microbiol.* **6**, 2845-2856 (1992).
136. Tolner,B., Poolman,B., Wallace,B. & Konings,W.N. Revised nucleotide sequence of the *gltP* gene, which encodes the proton-glutamate-aspartate transport protein of *Escherichia coli* K-12. *J. Bacteriol.* **174**, 2391-2393 (1992).
137. Engelke,T., Jording,D., Kapp,D. & Puhler,A. Identification and sequence analysis of the *Rhizobium meliloti* *dctA* gene encoding the C4-dicarboxylate carrier. *J. Bacteriol.* **171**, 5551-5560 (1989).
138. Chaudhry,F.A. *et al.* Glutamate transporters in glial plasma membranes: highly differentiated localizations revealed by quantitative ultrastructural immunocytochemistry. *Neuron* **15**, 711-720 (1995).
139. Conti,F., DeBiasi,S., Minelli,A., Rothstein,J.D. & Melone,M. EAAC1, a high-affinity glutamate transporter, is localized to astrocytes and gabaergic neurons besides pyramidal cells in the rat cerebral cortex. *Cereb. Cortex* **8**, 108-116 (1998).
140. Kugler,P. & Schmitt,A. Glutamate transporter EAAC1 is expressed in neurons and glial cells in the rat nervous system. *Glia* **27**, 129-142 (1999).
141. Dehnes,Y. *et al.* The glutamate transporter EAAT4 in rat cerebellar Purkinje cells: a glutamate-gated chloride channel concentrated near the synapse in parts of the dendritic membrane facing astroglia. *J. Neurosci.* **18**, 3606-3619 (1998).

142. Tanaka,J., Ichikawa,R., Watanabe,M., Tanaka,K. & Inoue,Y. Extra-junctional localization of glutamate transporter EAAT4 at excitatory Purkinje cell synapses. *Neuroreport* **8**, 2461-2464 (1997).
143. Yamada,K. *et al.* EAAT4 is a post-synaptic glutamate transporter at Purkinje cell synapses. *Neuroreport* **7**, 2013-2017 (1996).
144. Pow,D.V. & Barnett,N.L. Developmental expression of excitatory amino acid transporter 5: a photoreceptor and bipolar cell glutamate transporter in rat retina. *Neurosci. Lett.* **280**, 21-24 (2000).
145. Rauen,T. & Kanner,B.I. Localization of the glutamate transporter GLT-1 in rat and macaque monkey retinæ. *Neurosci. Lett.* **169**, 137-140 (1994).
146. Rauen,T., Rothstein,J.D. & Wassle,H. Differential expression of three glutamate transporter subtypes in the rat retina. *Cell Tissue Res.* **286**, 325-336 (1996).
147. Conradt,M. & Stoffel,W. Inhibition of the high-affinity brain glutamate transporter GLAST-1 via direct phosphorylation. *J. Neurochem.* **68**, 1244-1251 (1997).
148. Gonzalez,M.I. & Ortega,A. Regulation of the Na⁺-dependent high affinity glutamate/aspartate transporter in cultured Bergmann glia by phorbol esters. *J. Neurosci. Res.* **50**, 585-590 (1997).
149. Gonzalez,M.I. & Robinson,M.B. Protein KINASE C-Dependent Remodeling of Glutamate Transporter Function. *Mol. Interv.* **4**, 48-58 (2004).
150. Gonzalez,M.I. & Ortega,A. Regulation of high-affinity glutamate uptake activity in Bergmann glia cells by glutamate. *Brain Res.* **866**, 73-81 (2000).
151. Casado,M., Zafra,F., Aragon,C. & Gimenez,C. Activation of high-affinity uptake of glutamate by phorbol esters in primary glial cell cultures. *J. Neurochem.* **57**, 1185-1190 (1991).
152. Ganel,R. & Crosson,C.E. Modulation of human glutamate transporter activity by phorbol ester. *J. Neurochem.* **70**, 993-1000 (1998).

153. Kalandadze,A., Wu,Y. & Robinson,M.B. Protein kinase C activation decreases cell surface expression of the GLT-1 subtype of glutamate transporter. Requirement of a carboxyl-terminal domain and partial dependence on serine 486. *J. Biol. Chem.* **277**, 45741-45750 (2002).
154. Do,S.H., Kamatchi,G.L., Washington,J.M. & Zuo,Z. Effects of volatile anesthetics on glutamate transporter, excitatory amino acid transporter type 3: the role of protein kinase C. *Anesthesiology* **96**, 1492-1497 (2002).
155. Gonzalez,M.I., Kazanietz,M.G. & Robinson,M.B. Regulation of the neuronal glutamate transporter excitatory amino acid carrier-1 (EAAC1) by different protein kinase C subtypes. *Mol. Pharmacol.* **62**, 901-910 (2002).
156. Trotti,D., Peng,J.B., Dunlop,J. & Hediger,M.A. Inhibition of the glutamate transporter EAAC1 expressed in *Xenopus* oocytes by phorbol esters. *Brain Res.* **914**, 196-203 (2001).
157. Barbour,B., Brew,H. & Attwell,D. Electrogenic glutamate uptake in glial cells is activated by intracellular potassium. *Nature* **335**, 433-435 (1988).
158. Kanai,Y. *et al.* Electrogenic properties of the epithelial and neuronal high affinity glutamate transporter. *J. Biol. Chem.* **270**, 16561-16568 (1995).
159. Zerangue,N. & Kavanaugh,M.P. Flux coupling in a neuronal glutamate transporter. *Nature* **383**, 634-637 (1996).
160. Lehre,K.P., Levy,L.M., Ottersen,O.P., Storm-Mathisen,J. & Danbolt,N.C. Differential expression of two glial glutamate transporters in the rat brain: quantitative and immunocytochemical observations. *J. Neurosci.* **15**, 1835-1853 (1995).
161. Milton,I.D. *et al.* Expression of the glial glutamate transporter EAAT2 in the human CNS: an immunohistochemical study. *Brain Res. Mol. Brain Res.* **52**, 17-31 (1997).
162. Rothstein,J.D. *et al.* Localization of neuronal and glial glutamate transporters. *Neuron* **13**, 713-725 (1994).

163. Sonders,M.S. & Amara,S.G. Channels in transporters. *Curr. Opin. Neurobiol.* **6**, 294-302 (1996).
164. Lehre,K.P. & Danbolt,N.C. The number of glutamate transporter subtype molecules at glutamatergic synapses: chemical and stereological quantification in young adult rat brain. *J. Neurosci.* **18**, 8751-8757 (1998).
165. Bednarski,E., Lauterborn,J.C., Gall,C.M. & Lynch,G. Lysosomal dysfunction reduces brain-derived neurotrophic factor expression. *Exp. Neurol.* **150**, 128-135 (1998).
166. Bergles,D.E. & Jahr,C.E. Synaptic activation of glutamate transporters in hippocampal astrocytes. *Neuron* **19**, 1297-1308 (1997).
167. Diamond,J.S. & Jahr,C.E. Transporters buffer synaptically released glutamate on a submillisecond time scale. *J. Neurosci.* **17**, 4672-4687 (1997).
168. Mennerick,S. *et al.* Substrate turnover by transporters curtails synaptic glutamate transients. *J. Neurosci.* **19**, 9242-9251 (1999).
169. Rothstein,J.D., Van Kammen,M., Levey,A.I., Martin,L.J. & Kuncl,R.W. Selective loss of glial glutamate transporter GLT-1 in amyotrophic lateral sclerosis. *Ann. Neurol.* **38**, 73-84 (1995).
170. Casado,M. *et al.* Phosphorylation and modulation of brain glutamate transporters by protein kinase C. *J. Biol. Chem.* **268**, 27313-27317 (1993).
171. Kalandadze,A., Wu,Y., Fournier,K. & Robinson,M.B. Identification of motifs involved in endoplasmic reticulum retention-forward trafficking of the GLT-1 subtype of glutamate transporter. *J. Neurosci.* **24**, 5183-5192 (2004).
172. Fairman,W.A. & Amara,S.G. Functional diversity of excitatory amino acid transporters: ion channel and transport modes. *Am. J. Physiol* **277**, F481-F486 (1999).
173. Welsh,J.P. *et al.* Why do Purkinje cells die so easily after global brain ischemia? Aldolase C, EAAT4, and the cerebellar contribution to posthypoxic myoclonus. *Adv. Neurol.* **89**, 331-359 (2002).

174. Wadiche,J.I., Amara,S.G. & Kavanaugh,M.P. Ion fluxes associated with excitatory amino acid transport. *Neuron* **15**, 721-728 (1995).
175. Zerangue,N., Schwappach,B., Jan,Y.N. & Jan,L.Y. A new ER trafficking signal regulates the subunit stoichiometry of plasma membrane K(ATP) channels. *Neuron* **22**, 537-548 (1999).
176. Palmada,M., Dieter,M., Boehmer,C., Waldegger,S. & Lang,F. Serum and glucocorticoid inducible kinases functionally regulate ClC-2 channels. *Biochem. Biophys. Res. Commun.* **321**, 1001-1006 (2004).
177. Embark,H.M. *et al.* Regulation of CLC-Ka/barttin by the ubiquitin ligase Nedd4-2 and the serum- and glucocorticoid-dependent kinases. *Kidney Int.* **66**, 1918-1925 (2004).
178. Palmada,M. *et al.* Regulation of intestinal phosphate cotransporter NaPi IIb by ubiquitin ligase Nedd4-2 and by serum- and glucocorticoid-dependent kinase 1. *Am. J. Physiol Gastrointest. Liver Physiol* **287**, G143-G150 (2004).
179. Guo,H. *et al.* Increased expression of the glial glutamate transporter EAAT2 modulates excitotoxicity and delays the onset but not the outcome of ALS in mice. *Hum. Mol. Genet.* **12**, 2519-2532 (2003).
180. Wisman,L.A., van Muiswinkel,F.L., de Graan,P.N., Hol,E.M. & Bar,P.R. Cells over-expressing EAAT2 protect motoneurons from excitotoxic death in vitro. *Neuroreport* **14**, 1967-1970 (2003).
181. Legay,V. *et al.* Impaired glutamate uptake and EAAT2 downregulation in an enterovirus chronically infected human glial cell line. *Eur. J. Neurosci.* **17**, 1820-1828 (2003).
182. Meyer,T. *et al.* The RNA of the glutamate transporter EAAT2 is variably spliced in amyotrophic lateral sclerosis and normal individuals. *J. Neurol. Sci.* **170**, 45-50 (1999).
183. Dutuit,M. *et al.* Decreased expression of glutamate transporters in genetic absence epilepsy rats before seizure occurrence. *J. Neurochem.* **80**, 1029-1038 (2002).

184. Proper,E.A. *et al.* Distribution of glutamate transporters in the hippocampus of patients with pharmaco-resistant temporal lobe epilepsy. *Brain* **125**, 32-43 (2002).
185. Sander,T. *et al.* Variation of the genes encoding the human glutamate EAAT2, serotonin and dopamine transporters and Susceptibility to idiopathic generalized epilepsy. *Epilepsy Res.* **41**, 75-81 (2000).
186. Honig,L.S., Chambliss,D.D., Bigio,E.H., Carroll,S.L. & Elliott,J.L. Glutamate transporter EAAT2 splice variants occur not only in ALS, but also in AD and controls. *Neurology* **55**, 1082-1088 (2000).
187. Rodriguez-Kern,A. *et al.* Beta-amyloid and brain-derived neurotrophic factor, BDNF, up-regulate the expression of glutamate transporter GLT-1/EAAT2 via different signaling pathways utilizing transcription factor NF-kappaB. *Neurochem. Int.* **43**, 363-370 (2003).
188. Vorwerk,C.K. *et al.* Depression of retinal glutamate transporter function leads to elevated intravitreal glutamate levels and ganglion cell death. *Invest Ophthalmol. Vis. Sci.* **41**, 3615-3621 (2000).
189. Lopez-Redondo,F., Nakajima,K., Honda,S. & Kohsaka,S. Glutamate transporter GLT-1 is highly expressed in activated microglia following facial nerve axotomy. *Brain Res. Mol. Brain Res.* **76**, 429-435 (2000).
190. Vera-Portocarrero,L.P. *et al.* Rapid changes in expression of glutamate transporters after spinal cord injury. *Brain Res.* **927**, 104-110 (2002).
191. Douen,A.G. *et al.* Preconditioning with cortical spreading depression decreases inraischemic cerebral glutamate levels and down-regulates excitatory amino acid transporters EAAT1 and EAAT2 from rat cerebral cortex plasma membranes. *J. Neurochem.* **75**, 812-818 (2000).
192. Wulff,P. *et al.* Impaired renal Na(+) retention in the sgk1-knockout mouse. *J. Clin. Invest* **110**, 1263-1268 (2002).
193. Lawlor,M.A. *et al.* Essential role of PDK1 in regulating cell size and development in mice. *EMBO J.* **21**, 3728-3738 (2002).

194. Boehmer,C. *et al.* Post-translational regulation of EAAT2 function by co-expressed ubiquitin ligase Nedd4-2 is impacted by SGK kinases. *J. Neurochem.* **97**, 911-921 (2006).
195. Gamboa,C. & Ortega,A. Insulin-like growth factor-1 increases activity and surface levels of the GLAST subtype of glutamate transporter. *Neurochem. Int.* **40**, 397-403 (2002).
196. Sims,K.D., Straff,D.J. & Robinson,M.B. Platelet-derived growth factor rapidly increases activity and cell surface expression of the EAAC1 subtype of glutamate transporter through activation of phosphatidylinositol 3-kinase. *J. Biol. Chem.* **275**, 5228-5237 (2000).
197. Zeleniaia,O. *et al.* Epidermal growth factor receptor agonists increase expression of glutamate transporter GLT-1 in astrocytes through pathways dependent on phosphatidylinositol 3-kinase and transcription factor NF-kappaB. *Mol. Pharmacol.* **57**, 667-678 (2000).
198. Gegelashvili,G. & Schousboe,A. High affinity glutamate transporters: regulation of expression and activity. *Mol. Pharmacol.* **52**, 6-15 (1997).
199. Davis,K.E. *et al.* Multiple signaling pathways regulate cell surface expression and activity of the excitatory amino acid carrier 1 subtype of Glu transporter in C6 glioma. *J. Neurosci.* **18**, 2475-2485 (1998).
200. Dowd,L.A. & Robinson,M.B. Rapid stimulation of EAAC1-mediated Na⁺-dependent L-glutamate transport activity in C6 glioma cells by phorbol ester. *J. Neurochem.* **67**, 508-516 (1996).
201. Lortet,S. *et al.* Effects of PKA and PKC modulators on high affinity glutamate uptake in primary neuronal cell cultures from rat cerebral cortex. *Neuropharmacology* **38**, 395-402 (1999).
202. Pisano,P., Samuel,D., Nieoullon,A. & Kerkerian-Le Goff,L. Activation of the adenylate cyclase-dependent protein kinase pathway increases high affinity glutamate uptake into rat striatal synaptosomes. *Neuropharmacology* **35**, 541-547 (1996).

203. Staley,K., Smith,R., Schaack,J., Wilcox,C. & Jentsch,T.J. Alteration of GABAA receptor function following gene transfer of the CLC-2 chloride channel. *Neuron* **17**, 543-551 (1996).

Acknowledgement

First of all, I would like to thank my Ph D advisor Prof. Dr. Med. Florian Lang for giving me this great opportunity to work under his guidance. I am also grateful to his support and encouragement to enlighten my career.

I would like to utilize this moment to show my gratitude to my Ph D supervisor Privatdozent Dr. rer. nat. Monica Palmada for her invaluable guidance and constant encouragement in my research works.

I am particularly indebted to Privatdozent Dr. rer. nat. Christoph Böhmer for teaching electrophysiology, providing good working-environment and guiding in laboratory organization.

I am very grateful to Ms. Brigitte Noll and Ms. Annunziata Fragasso for their technical assistance.

I want to thank my friends Azeemudeen Husain, Leenus Martin, Prakash Mohan Peranandam, Ravisankar Kasinathan and Sankarganesh Jeyaraj for their encouragement, support and suggestions.

Finally I would like to thank all other colleagues of Physiology Institute for making the institute, a good place to work with.

Curriculum Vitae

Jeyaganesh Rajamanickam

Personal Data

Date of Birth 1979/06/11
Place of Birth Madurai, India
Sex Male
Nationality Indian
Marital Status Single
e-mail jeyaganesh.rajamanickam@gmail.com
Phone +49 (0)174 1636423



Work Address Institute for Physiology I
Gmelinstrasse 5
72076 Tuebingen
Germany

Academic training

2003-present **PhD work**
Eberhard-Karls University of Tuebingen, Germany
“The serum and glucocorticoid inducible kinase in the regulation of sodium coupled amino acid transporters”
Prospective examination date: January 2007

April 2002 **M. Sc.**
Microbiology, Bharathidasan University, Trichy, TN, India:
“Identification of integral membrane protein genes from a cDNA library of *Aspergillus fumigatus*”

April 2000 **B. Sc.**
Microbiology. Madurai Kamaraj University Madurai, TN, India

Methodological expertise

- *Molecular Biology / Biochemistry*

Heterologous protein expression in *Xenopus laevis* oocytes

Site-directed mutagenesis

In vitro transcription / translation

Generation and screening of cDNA libraries.

Generation of recombinant proteins

Cell surface expression analysis of membrane proteins by biotinylation and chemiluminescence

Gene silencing by RNA interference

Detection of protein phosphorylation by immunoprecipitation / immunoblotting and *in vitro* kinase assays

PCR-based techniques for cloning and sequencing, stable and transient expression of membrane proteins in *Xenopus laevis* oocytes

- *Functional Methods*

Animal care and surgery of *Xenopus laevis* oocytes

Heterologous expression and functional characterization of recombinant proteins in *Xenopus laevis* oocytes

Radiolabeled tracer flux measurements

Two electrode voltage-clamp

- *Basic microbiological techniques*

Publications (peer review)

1. Dieter M, Palmada M, **Rajamanickam J**, Aydin A, Busjahn A, Boehmer C, Luft FC, Lang F; 'Regulation of glucose transporter SGLT1 by ubiquitin ligase Nedd4-2 and kinases SGK1, SGK3 and PKB'. **Obse Res.** 12: 862-870, 2004.
2. Embark HM, Bohmer C, Palmada M, **Rajamanickam J**, Wyatt AW, Wallisch S, Capasso G, Waldegger P, Seyberth Hw, Waldeggers S, LangF; 'Regulation of ClC-Ka/barttin by the ubiquitin ligase Nedd4-2 and the serum- and glucocorticoid-dependent kinases'. **Kidney Int.** 66: 1918-1925, 2004.
3. Bohmer C, Philippin M, **Rajamanickam J**, Mack A, Broer s, Palmada, Lang F; 'Stimulation of the EAAT4 glutamate transporter by SGK protein kinase isoforms and PKB'. **Biochem Biophys Res Commun.** 324: 1242-1248, 2004.

4. Boehmer C, **Rajamanickam J**, Schniepp R, Kohler K, Wulff P, Kuhl D, Palmada M, Lang F; 'Regulation of the excitatory amino acid transporter EAAT5 by the serum and glucocorticoid dependent kinases SGK1 and SGK3'. *Biochem Biophys Res Commun.* 329: 738-742, 2005.
5. Palmada M, Boehmer C, Akel A, **Rajamanickam J**, Jeyaraj S, Keller K, Lang F; 'SGK1 kinase upregulates GLUT1 activity and plasma membrane expression'. *Diabetes* 55: 421-427, 2006.
6. Boehmer C, Palmada M, **Rajamanickam J**, Schniepp R, Amara S, Lang F; 'Post-translational regulation of EAAT2 function by co-expressed ubiquitin ligase Nedd4-2 is impacted by SGK kinases'. *J Neurochem.* 97: 911-921, 2006.
7. Huang DY, Boini KM, Osswald H, Friedrich B, Artunc F, Ullrich S, **Rajamanickam J**, Palmada M, Wulff P, Kuhl D, Vallon V and Lang F, 'Resistance of mice lacking the serum and glucocorticoid inducible kinase SGK1 against salt-sensitive hypertension induced by high fat diet'. *Am J Physiol-Renal Physiol.* 291: 1264-1273, 2006.
8. Maier G, Palmada M, **Rajamanickam J**, Shumilina E, Böhmer C and Lang F, 'Upregulation of HERG channels by the serum and glucocorticoid inducible kinase isoform SGK3'. *Cell Physiol Biochem.* 18: 177-186, 2006.
9. **Rajamanickam J**, Palmada M, Lang F and Böhmer C, 'EAAT4 phosphorylation at the SGK1 consensus site is required for transport modulation by the kinase'. In press, *J Neurochem*, 2007.

References

Prof. Dr. med. Florian Lang

Chairman

Institute of Physiology I

Eberhard-Karls University of Tuebingen

Gmelinstrasse 5

72076 Tuebingen

Germany

Phone +49 (0)7071 29-72194

FAX +49 (0)7071 29-3073

e-mail: florian.lang@uni-tuebingen.de

Privatdozent Dr. rer. nat. Christoph Böhmer

Associate Professor

Institute of Physiology I

Eberhard-Karls University of Tuebingen

Gmelinstrasse 5

72076 Tuebingen

Germany

Phone +49 (0)7071 29-73071

FAX +49 (0)7071 29-3073

e-mail: christoph.boehmer@uni-tuebingen.de

Privatdozent Dr. rer. nat. Monica Palmada

Associate Professor

Institute of Physiology I

Eberhard-Karls University of Tuebingen

Gmelinstrasse 5

72076 Tuebingen

Germany

Phone +49 (0)7071 29-76890

FAX +49 (0)7071 29-3073

e-mail: monica.palmada@uni-tuebingen.de